







To Prevent Accidents & Losses : use TAJLOTO

# LOCKOUT TAGOUT DEVICES



## Our Services :

-  Surveys
-  Training
-  Audits
-  Machine Specific Procedures (MSP)
-  Policy & Procedures
-  LOCKOUT / TAGOUT devices
-  Installation & Implementation



**SAFETYWALA**  
Equipments LLP.



**TAJLOTO SAFETY**  
Private Limited  
LOCKOUT TAGOUT MANUFACTURER

# Products Index



COMPANY  
PROFILE  
& OSHA  
STANDARD



LOCKOUT  
SAFETY  
PADLOCK

1 - 15



LOCKOUT  
HASP

16 - 26



CABLE  
LOCKOUT

27 - 35



VALVE  
LOCKOUT

36 - 43



CYLINDER  
LOCKOUT &  
PNEUMATIC  
LOCKOUT

44 - 47



PLUG  
LOCKOUT,  
PIN &  
SLEEVE  
LOCKOUT

48 - 53



CIRCUIT  
BREAKER  
LOCKOUT

54 - 67



DIGITAL  
PANEL  
BLOCKING  
BAR  
LOCKOUT

68 - 70



FUSE  
LOCKOUT

71 - 73

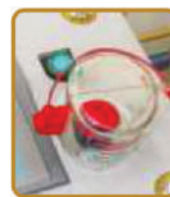

ELECTRICAL  
PANEL  
LOCKOUT

74 - 82



GROUP  
LOCK  
BOXES  
(GLB)

83 - 91



LOCKOUT TAGOUT  
STATION,  
PADLOCK & KEY STATION

92 - 97



HOOKS &  
RAIL TYPE  
STATION

98 - 99

# Products Index



**SHADOW  
LOCKOUT  
STATION**

**100 - 105**



**LOCKOUT  
TAGOUT  
KITS**

**106 -124**



**LOCKOUT  
TAGS**

**125 -139**



**ENERGY SOURCE  
IDENTIFICATION  
MINI TAGS**

**140 - 142**



**SCAFFOLDING  
HOLDERS &  
TAGS / INSERTS**

**143 - 151**



**LOCKOUT/  
TAGOUT  
SIGNS &  
LABELS**

**152 - 156**



**LOCKOUT/  
TAGOUT  
POSTERS**

**157 - 160**



**STEERING WHEEL LOCKOUT  
COVER & CONFINED SPACE  
LOCKOUT COVER**

**161 - 163**



**SAFETY DATA  
SHEETS  
BOX / STATION  
& FILES**

**164 - 170**



**LOCKOUT/  
TAGOUT  
OTHER  
PRODUCTS**

**171 - 181**

“ Working safely  
is like breathing  
if you don't... you die. ”

Use **LOCKOUT TAGOUT** Safety Devices  
before  
**MAINTENANCE** or **SERVICING**



## COMPANY PROFILE



### About Us

We **TAJLOTO SAFETY Private Limited**, introduce ourselves as one of the Leading Supplier and Service Provider for **LOCKOUT TAGOUT Safety Equipment**. We have Expertise Knowledge of more than a decade in the Field of Safety. We aim at manufacturing our devices to not only conform to the world's safety standards, but also that the customers perceive something of great intrinsic value when they use it.

### Why Us?

Our Core Business has long been the Distribution and Manufacturing of Safety Devices. Today, We are increasingly focused on the rising demand for Safety Services. The requirement to assess the likelihood of an injury in the work place can be a very complex task even though there are volumes of Safety Standards available. If your facility wants to have the resources that are required to fully understand risk assessment and implement risk reduction measures **TAJLOTO Safety Devices can provide you with the Right Solutions.**

### Our Mission

Safety is our number one core value. Our mission is to provide our clients with best safety products and services designed to reduce workplace injuries and accidents, which promotes client profitability.

### Our Values :

- 👑 Our World revolves around our Customers
- 👑 Technical Competence
- 👑 Team Work
- 👑 Passion for Excellence
- 👑 Commitments
- 👑 Ethics



**TAJLOTO SAFETY**  
Private Limited  
LOCKOUT TAGOUT MANUFACTURER

**Company Name** : **TAJLOTO SAFETY Private Limited**  
**Manuf. Unit Address** : **412/1, Street no. 4, Industrial Area, Upper Anand Parbat, New Delhi - 110005 (India)**  
**Main Products** : **Lockout Tagout Safety Devices**  
**Company GSTIN No.** : **07AAICT9806C1Z9**  
**Company Website** : **www.tajlotosafety.in**  
**Company E-Mail & Contact Number** : **tajlotosafety@gmail.com 74289 122 74, 73033 859 78**  
**tajlotoexport@gmail.com 74289 122 75, 73033 859 77**  
**tajlotoindia@gmail.com 74289 122 76, 72899 275 47**

### Nayeem Khan

MANAGING DIRECTOR &  
CO FOUNDER OF TAJLOTO SAFETY PVT LTD  
Company E-Mail : [tajlotosale@gmail.com](mailto:tajlotosale@gmail.com)

## OSHA Lockout Standard

### OSHA 29 CFR 1910.147: THE CONTROL OF HAZARDOUS ENERGY (LOCKOUT/TAGOUT)

**1. Scope :** This standard covers the servicing and maintenance of machines and equipment in which the unexpected energization or start up of the machines or equipment, or release of stored energy could cause injury to employees. This standard establishes minimum performance requirements for the control of such hazardous energy - electrical, mechanical, hydraulic, pneumatic, chemical, thermal, and other energy sources.

**2. Application :** This standard applies to the control of energy during servicing and / or maintenance of machines and equipment.

**3. Purpose :** This section requires employers to establish a program and utilize procedures for affixing appropriate lockout devices or tagout devices to energy isolating devices, and to otherwise disable machines or equipment to prevent unexpected energization, start-up or release of stored energy in order to prevent injury to employees.

#### Why is controlling hazardous energy sources important?

Employees servicing or maintaining machines or equipment may be exposed to serious physical harm or death if hazardous energy is not properly controlled. In America itself - Shop floor workers, machine operators, and laborers are among more than 30 million workers who service equipment and face the greatest risk. Compliance with the lockout/ tagout standard prevents an estimated thousands of fatalities and Lacs of injuries each year.

#### How can you protect workers?

The lockout/tagout standard establishes the employer's responsibility to protect employees from hazardous energy sources on machines and equipments during service and maintenance. The standard gives each employer the flexibility to develop an energy control program suited to the needs of the particular workplace and the types of machines and equipment being maintained or serviced. This is generally done by affixing the appropriate lockout or tagout devices to energy-isolating devices and by de-energizing machines and equipment. The standard outlines the steps required to do this.

#### What do employees need to know?

Employees need to be trained to ensure that they know, understand, and follow the applicable provisions of the hazardous energy control procedures. The training must cover at least three areas: aspects of the employer's energy control program; elements of the energy control procedure relevant to the employee's duties or assignment; and the various requirements of the OSHA standards related to lockout/tagout.





## LOCKOUT SAFETY PADLOCK

*Our Lockout Padlock range give you the physical tools to help you implement and maintain an effective Safety Lockout program as per your own OSHA Policy & Procedures and your own Energy Control Program, to prevent accidents and protect your employees.*

*Safety Lockout Padlocks are available in range of colors to increase visibility and allow workers to readily see if a device is isolated. Padlock numbering / Metal Tagging, Etching on Shackle, Logo and Department Labels, photographs of employees or employee codes etc. on the personalized locks are also available on request and at an extra cost.*

DOMESTIC | [tajlotoindia@gmail.com](mailto:tajlotoindia@gmail.com)  
EXPORT | [tajlotoexport@gmail.com](mailto:tajlotoexport@gmail.com)



[tajlotosafety@gmail.com](mailto:tajlotosafety@gmail.com)  
[www.tajlotosafety.in](http://www.tajlotosafety.in)

## OSHA LOCKOUT / TAGOUT REGULATION

- 1910.147(c)(5) OSHA lockout Device requirements state that lockout devices must:
  - Be provided by the employer.
  - Be standardized by size, shape or color.
  - Be distinguishable from locks used for other purposes. Lockout locks should only be used for lockout.
  - Identify the individual who applied the lock (both tags and lock labels are acceptable for this purpose).
  - Be capable of withstanding the usage environment and must be strong enough to prevent removal except by using excessive force with special tools, such as bolt cutters.
  - Most importantly, whenever lockout devices are applied, they must remain under the exclusive control of the individual who attached them. No employee should be able to open a lock attached by someone else.

## KEYING OPTIONS :

Kindly select the padlocks carefully as per your requirements.

- Shackle Type / Shackle Size / Padlock Body Color
- Same Key** (means all the supplied locks have one common key)
- Key Different** (means that all the supplied locks can be opened with their respective keys only)
- Key Different + Master Key** (means that all the supplied locks can be opened with their respective keys + with one master key)

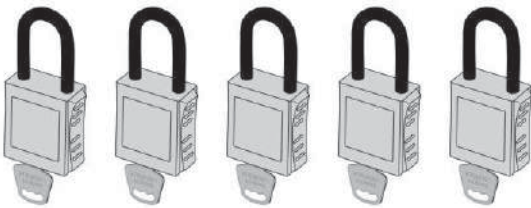

### Key Different (KD)

means that every lock has its individual key and the key for one lock can not open another lock in any case.

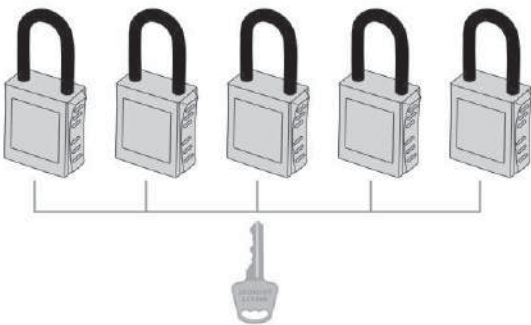

### Same Key (SK)

means all locks in a set can be opened with the same key.

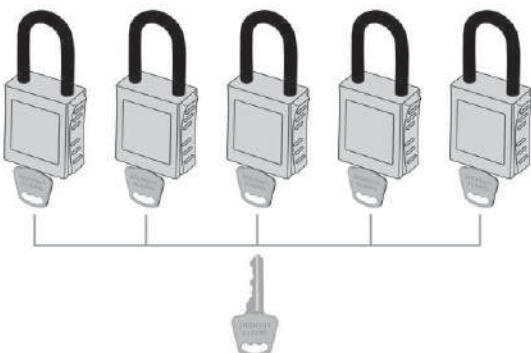

### Master Key (MK)

can be used to open multiple locks that are keyed differently.

*If Number of extra keys required.  
They can be supplied against the confirmed order  
and at an extra cost.*

## JACKET PADLOCKS REGULAR & LONG SHACKLE



**TL - JPRS 3 - KD**  
Taj Loto - Jacket Padlock  
with Regular Shackle Set of 3 - Key Different

**TL - JPRS 3 - SK**  
Taj Loto - Jacket Padlock  
with Regular Shackle Set of 3 - Same Key



**TL - JPLS 3 - KD**  
Taj Loto - Jacket Padlock  
with Long Shackle Set of 3 - Key Different

**TL - JPLS 3 - SK**  
Taj Loto - Jacket Padlock  
with Long Shackle Set of 3 - Same Key



- ⚡ A set of three lockout jacket padlocks supplied with injection moulded De-electric BLUE / RED & YELLOW JACKETS.  
Specifically drafted instruction label for each lock is provided.
- ⚡ Separate locks are also available in different colors (Green / Blue / Red / Yellow / Black & Orange) in any quantity.
- ⚡ **Each lock is supplied with 3 keys.**
- ⚡ Available in Regular & Long steel shackles.



**TL - JPRS - KD**  
Taj Loto - Jacket Padlock  
with Regular Shackle  
Key Different

**TL - JPRS - SK**  
Taj Loto - Jacket Padlock  
with Regular Shackle - Same Key\*  
(minimum quantity applicable)



**TL - JPLS - KD**  
Taj Loto - Jacket Padlock  
with Long Shackle - Key Different

**TL - JPLS - SK**  
Taj Loto - Jacket Padlock  
with Long Shackle - Same Key\*  
(minimum quantity applicable)

**TL - JPLS - KD + MK**  
Taj Loto - Jacket Padlock with  
Long Shackle - Key Different  
+ Master Key\*  
(minimum quantity applicable)

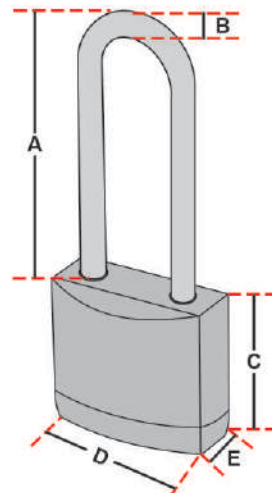

Dimension		
Model	TL - JPRS	TL - JPLS
Shackle Height (A)	26 mm	72 mm
Shackle Dia (B)	6 mm	6 mm
Body Height (C)	39 mm	39 mm
Body Width (D)	43 mm	43 mm
Body Depth (E)	20 mm	20 mm
Weight	140 gm	170 gm
3 Keys Weight	11 gm	11 gm

## JACKET PADLOCKS (DESIGN - 2) REGULAR & LONG SHACKLE



**TL - JPRS-2 S3 - KD**  
Taj Loto - Jacket Padlock-2  
with Regular Shackle Set of 3 - Key Different

**TL - JPRS-2 S3 - SK**  
Taj Loto - Jacket Padlock-2  
with Regular Shackle Set of 3 - Same Key



**TL - JPLS-2 S3 - KD**  
Taj Loto - Jacket Padlock-2  
with Long Shackle Set of 3 - Key Different

**TL - JPLS-2 S3 - SK**  
Taj Loto - Jacket Padlock-2  
with Long Shackle Set of 3 - Same Key



- ⚡ A set of three lockout jacket (design - 2) padlocks supplied with injection moulded De-electric BLUE / RED & YELLOW JACKETS.
- ⚡ Separate locks are also available in different colors (Green / Blue / Red / Yellow / Black & Orange) in any quantity.
- ⚡ Each lock is supplied with 3 keys.
- ⚡ Available in Regular & Long steel shackles.



**TL - JPRS-2 - KD**  
Taj Loto - Jacket Padlock-2  
with Regular Shackle  
Key Different

**TL - JPRS-2 - SK**  
Taj Loto - Jacket Padlock-2  
with Regular Shackle - Same Key\*  
(minimum quantity applicable)



**TL - JPLS-2 - KD**  
Taj Loto - Jacket Padlock-2  
with Long Shackle - Key Different

**TL - JPLS-2 - SK**  
Taj Loto - Jacket Padlock-2  
with Long Shackle - Same Key\*  
(minimum quantity applicable)

**TL - JPLS-2 - KD + MK**  
Taj Loto - Jacket Padlock-2 with  
Long Shackle - Key Different  
+ Master Key\*  
(minimum quantity applicable)

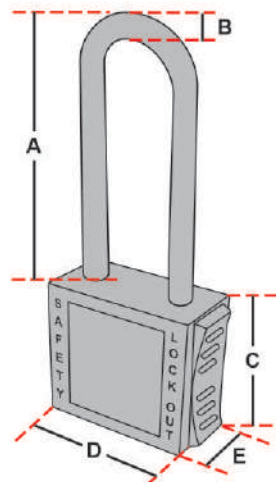

Dimension		
Model	TL - JPRS-2	TL - JPLS-2
Shackle Height (A)	26 mm	72 mm
Shackle Dia (B)	6 mm	6 mm
Body Height (C)	39 mm	39 mm
Body Width (D)	49 mm	49 mm
Body Depth (E)	22 mm	22 mm
Weight	140 gm	170 gm
3 Keys Weight	11 gm	11 gm

## PREMIER LOCKOUT SAFETY PADLOCKS METALLIC SHACKLE

- 6-pin precision-machined cylinder for extra security.
- Re-inforced Nylon body is non-conductive, non-sparking and resistant to chemicals and corrosion.
- Colour coded for easy identification, they can also be supplied with warning labels (Label Customization Accepted\*). Supplied with individually coded keys for optimum security
- Each padlock is supplied in a box with 1 key. (Extra keys available\*)
- Available in Hardened Steel shackle or with Stainless Steel Shackle (in 25 / 46mm shackle sizes) Stainless steel shackles are used for corrosive industrial / offshore environments.
- Most popular combination of **Master Key locks is of 5 Key Different locks with 1 master key.**
- Locks of any size / combination / colour or shackle types can be made & supplied on request.

The nylon body is carved / designed with ribs for easy gripping and handling. Supplied with an individual unique coded brass key and cylinder to differ 6-pin locking combinations. The Jack locking key mechanism does not allow the release of key, until the shackle is closed and the padlock is locked.



### TL - PLSP 46 - KD 3C

Taj Loto - Premier Lockout Safety Padlock with 46mm Shackle Height - Key Different Set of 3 Colours.

### TL - PLSP 85 - KD

Taj Loto - Premier Lockout Safety Padlock with 85mm Shackle Height - Key Different

### TL - PLSP 85 - SK

Taj Loto - PLSP with 85mm Shackle Height - Same Key\* (minimum quantity applicable)

### TL - PLSP 85 - KD+MK

Taj Loto - PLSP with 85mm Shackle Height - Key Different + Master Key\* (minimum quantity applicable)



### TL - PLSP - 25 KD

Taj Loto - Premier Lockout Safety Padlock with 25mm Shackle Height - Key Different

### TL - PLSP - 25 SK

Taj Loto - PLSP with 25mm Shackle Height - Same Key\* (minimum quantity applicable)

### TL - PLSP - 25 KD+MK

Taj Loto - PLSP with 25mm Shackle Height - Key Different + Master Key\* (minimum quantity applicable)



### TL - PLSP 46 - KD

Taj Loto - Premier Lockout Safety Padlock with 46mm Shackle Height - Key Different

### TL - PLSP 46 - SK

Taj Loto - PLSP with 46mm Shackle Height - Same Key\* (minimum quantity applicable)

### TL - PLSP 46 - KD+MK

Taj Loto - PLSP with 46mm Shackle Height - Key Different + Master Key\* (minimum quantity applicable)



Available colours\*

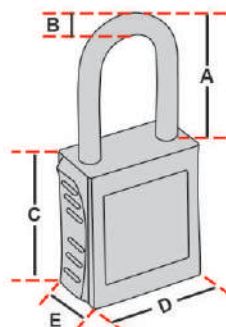

Dimension	TL - PLSP - 25	TL - PLSP - 46	TL - PLSP - 85
Model	TL - PLSP - 25	TL - PLSP - 46	TL - PLSP - 85
Shackle Height (A)	25 mm	46 mm	85 mm
Shackle Dia (B)	6 mm	6 mm	6 mm
Body Height (C)	45 mm	45 mm	45 mm
Body Width (D)	44 mm	44 mm	44 mm
Body Depth (E)	20 mm	20 mm	20 mm
Weight with 1 key	85 gm	95 gm	113 gm

## PREMIER LOCKOUT SAFETY PADLOCKS DE-ELECTRIC SHACKLE

Our De-Electric version of PLSP Locks have hardened **reinforced Nylon Shackle** which are **completely non-conductive** and ideal for their use on Electrical Panels.



### TL - DE-PLSP 46 - KD 3C

Taj Loto - De-Electric - Premier Lockout Safety Padlock with 46mm Shackle Height Key Different Set of 3 Colours.



### TL - DE-PLSP 46 - KD

Taj Loto - De-Electric - Premier Lockout Safety Padlock with 46mm Shackle Height - Key Different

### TL - DE-PLSP 46 - SK

Taj Loto - De-Electric - PLSP with 46mm Shackle Height - Same Key\* (minimum quantity applicable)

### TL - DE-PLSP 46 - KD+MK

Taj Loto - De-Electric - PLSP with 46mm Shackle Height - Key Different + Master Key\* (minimum quantity applicable)

### TL - DE-PLSP 85 - KD

Taj Loto - De-Electric - Premier Lockout Safety Padlock with 85mm Shackle Height Key Different

### TL - DE-PLSP 85 - SK

Taj Loto - De-Electric - PLSP with 85mm Shackle Height Same Key\* (minimum quantity applicable)

### TL - DE-PLSP 85 - KD+MK

Taj Loto - De-Electric - PLSP with 85mm Shackle Height Key Different + Master Key\* (minimum quantity applicable)



*Customization  
Accepted*

- 👑 Company Name / Logo
- 👑 Plant Location
- 👑 Lock Numbering
- 👑 Department Name
- 👑 Employee Name
- 👑 Employee Photo
- 👑 Employee Code No.
- 👑 Laser Engraving etc.

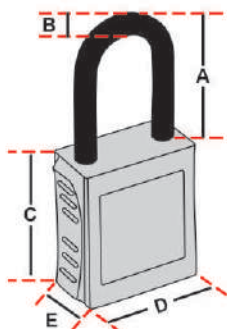

Dimension	TL-DE-PLSP-46	TL-DE-PLSP-85
Model	TL-DE-PLSP-46	TL-DE-PLSP-85
Shackle Height (A)	46 mm	85 mm
Shackle Dia (B)	6 mm	6 mm
Body Height (C)	45 mm	45 mm
Body Width (D)	44 mm	44 mm
Body Depth (E)	20 mm	20 mm
Weight with 1 key	63 gm	68 gm

Available colours\*



# LOCKOUT SAFETY PADLOCK



**TAJLOTO SAFETY PVT. LTD.**  
LOCKOUT TAGOUT MANUFACTURER

## PREMIER LOCKOUT LOCK - 6 METALLIC SHACKLE

- 6-pin precision-machined cylinder for extra security.
- Re-inforced Nylon body is non-conductive, non-sparking and resistant to chemicals and corrosion.
- Colour coded for easy identification, they can also be supplied with warning labels (Label Customization Accepted\*). Supplied with individually coded keys for optimum security
- Available in Hardened Steel shackle with 6mm shackle thickness.
- Most popular combination of **Master Key locks is of 5 Key Different locks with 1 master key.**



### TL - PLL-6 - 85 - KD

Taj Loto - Premier Lockout Lock-6 with 85mm Shackle Height Key Different

### TL - PLL-6 - 85 - SK

Taj Loto - PLL-6 with 85mm Shackle Height - Same Key\* (minimum quantity applicable)

### TL - PLL-6 - 85 - KD+MK

Taj Loto - PLL-6 with 85mm Shackle Height - Key Different + Master Key\* (minimum quantity applicable)



### TL - PLL-6 - 46 - KD

Taj Loto - Premier Lockout Lock-6 with 46mm Shackle Height Key Different

### TL - PLL-6 - 46 - SK

Taj Loto - PLL-6 with 46mm Shackle Height - Same Key\* (minimum quantity applicable)

### TL - PLL-6 - 46 - KD+MK

Taj Loto - PLL-6 with 46mm Shackle Height - Key Different + Master Key\* (minimum quantity applicable)

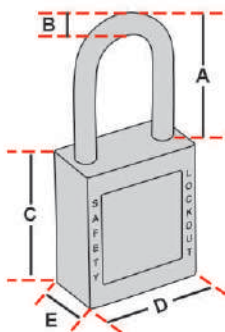

Dimension	TL - PLL-6 - 46	TL - PLL-6 - 85
Model	TL - PLL-6 - 46	TL - PLL-6 - 85
Shackle Height (A)	46 mm	85 mm
Shackle Dia (B)	6 mm	6 mm
Body Height (C)	45 mm	45 mm
Body Width (D)	38 mm	38 mm
Body Depth (E)	20 mm	20 mm
Weight with 1 key	93 gm	111 gm

Available colours\*



## PREMIER LOCKOUT LOCK - 6 DE-ELECTRIC NYLON SHACKLE

Our De-Electric version of PLSP-6 Locks have hardened **reinforced Nylon Shackle** which are **completely non-conductive** and ideal for their use on Electrical Panels.

- ⚙️ 6-pin precision-machined cylinder for extra security.
- ⚙️ Colour coded for easy identification, they can also be supplied with warning labels (Label Customization Accepted\*). Supplied with individually coded keys for optimum security.
- ⚙️ Most popular combination of **Master Key locks is of 5 Key Different locks with 1 master key.**



### TL - DE-PLL-6 - 85 - KD

Taj Loto - De-Electric - Premier Lockout Lock-6 with 85mm Shackle Height Key Different

### TL - DE-PLL-6 - 85 - SK

Taj Loto - De-Electric - PLL-6 with 85mm Shackle Height Same Key\* (minimum quantity applicable)

### TL - DE-PLL-6 - 85 - KD+MK

Taj Loto - De-Electric - PLL-6 with 85mm Shackle Height Key Different + Master Key\* (minimum quantity applicable)



- ⚙️ Company Name / Logo
- ⚙️ Plant Location
- ⚙️ Lock Numbering
- ⚙️ Department Name
- ⚙️ Employee Name
- ⚙️ Employee Photo
- ⚙️ Employee Code No.
- ⚙️ Laser Engraving etc.



### TL - DE-PLL-6 - 46 - KD

Taj Loto - De-Electric - Premier Lockout Lock-6 with 46mm Shackle Height Key Different

### TL - DE-PLL-6 - 46 - SK

Taj Loto - De-Electric - PLL-6 with 46mm Shackle Height Same Key\* (minimum quantity applicable)

### TL - DE-PLL-6 - 46 - KD+MK

Taj Loto - De-Electric - PLL-6 with 46mm Shackle Height Key Different + Master Key\* (minimum quantity applicable)

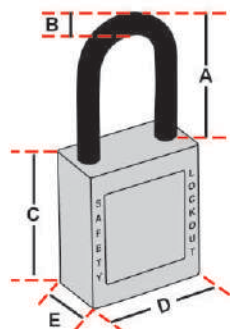

Dimension	TL-DE-PLL-6 - 46	TL-DE-PLL-6 - 85
Model	TL-DE-PLL-6 - 46	TL-DE-PLL-6 - 85
Shackle Height (A)	46 mm	85 mm
Shackle Dia (B)	6 mm	6 mm
Body Height (C)	45 mm	45 mm
Body Width (D)	38 mm	38 mm
Body Depth (E)	20 mm	20 mm
Weight with 1 key	61 gm	66 gm



## CABLE LOCKOUT SAFETY PADLOCKS

- ▣ Featuring an elongated, flexible cable, these padlocks are more versatile than standard safety padlocks, providing a multi-purpose solution.
- ▣ Flexible cable allows for effective lockout in tight spaces such as breaker cabinets or simultaneous lockout of several energy isolation points. Angle and twist the padlock cable in tight application areas.
- ▣ Complies with all OSHA requirements and makes it possible to secure several breaker lockouts simultaneously.
- ▣ Includes high-visibility safety label (label can be customized according to your requirements).
- ▣ Cable available in stainless steel with and without vinyl coating. And vinyl coated De-electric cable is also available which makes it more suitable for electrical lockout.
- ▣ **Cable is available from 1 feet to 4 feet. Other cable sizes are also available (more than 4 feet).**
- ▣ Standard colors are Red, Yellow, and Blue. Other colors are also available, minimum quantity 100 numbers.
- ▣ Each cable padlock is supplied with 1 key.

All cable padlock are **available in :**

- ▣ **Key Different (KD)**
- ▣ **Same Key (SK)**
- ▣ **Key Different + Master Key (KD+MK)**

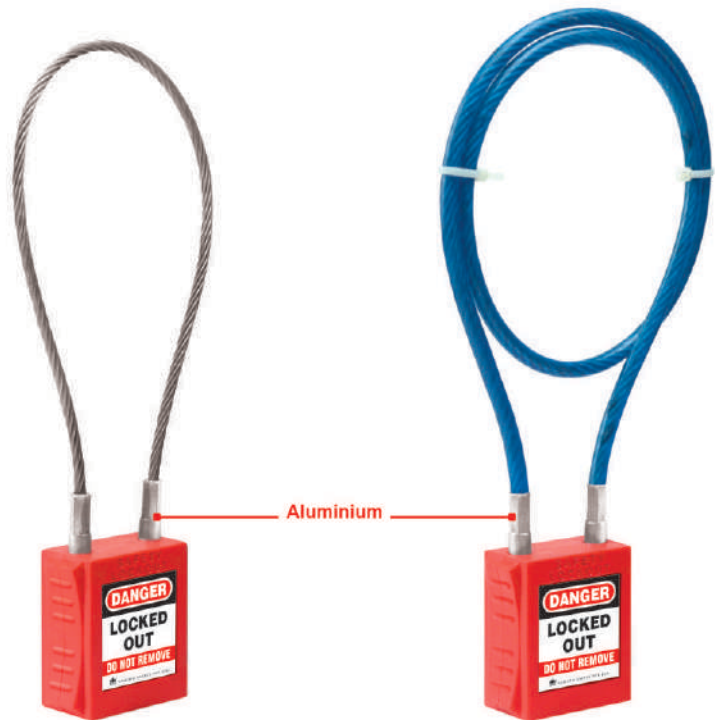

**TL - CP-1SSC**  
Taj Loto - Cable Padlock of  
1 Feet Stainless Steel Cable

**TL - CP-2VCSC**  
Taj Loto - Cable Padlock of  
2 feet Vinyl Coated Steel Cable

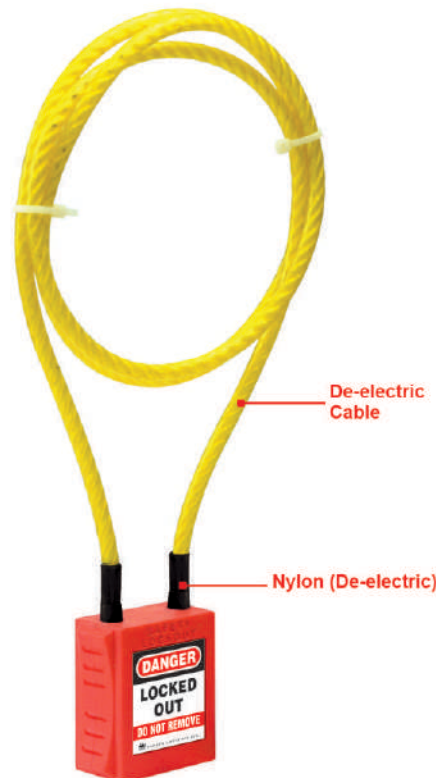

**TL - CP-3VDCD**  
Taj Loto - Cable Padlock of  
3 feet Vinyl Coated De-electric Cable



## PADLOCK LABELS

Use these labels on lockout safely padlocks TL- JPLS, JPRS, PLSP & DE-PLSP to clearly instruct workers when a machine is down for service or maintenance.

### Padlock Labels for TL- JPLS, TL- JPRS



**TL - JPL - A Type**  
Taj Loto - Jacket Padlock Label - A Type

### Padlock Labels for TL - PLSP & TL - DE-PLSP



### Customized label example



**TL - JPL - B Type**  
Taj Loto - Jacket Padlock Label - B Type



**TL - JPL - C Type**  
Taj Loto - Jacket Padlock Label - C Type



**TL - JPL - D Type**  
Taj Loto - Jacket Padlock Label - D Type



**TL - JPL - E Type**  
Taj Loto - Jacket Padlock Label - E Type



*All the labels can be made and supplied in any language and colour\**

## PADLOCK EYES



These Padlock Eyes help you to comply with OSHA Standard, which require the equipment / electrical panels to be locked at the time of servicing / maintenance.

Surface mounted padlock eyes help you to install padlocks easily on the electrical panels or other areas where the isolation points are hidden in the cabinets.

- ✦ Made from solid stainless steel constant thickness sheet.
- ✦ Die cut to hold most of the EXPORTly available padlocks.
- ✦ They can be screwed / bolted or rivetted.
- ✦ Each set contain - 10 nos. of padlock eyes.
- ✦ Combo pack contains 2 nos. of each type (Small / Medium / Large Padlock eyes) - Total 12 Nos. + Buffer (10 nos.) / Rivet (24 nos.)



Taj Loto - Flat Padlock Eye - Small / Medium / Large / Extra Large

### TL - PE COMBO

Taj Loto - Padlock Eye - Combo  
Small / Medium / Large / Buffer (10 nos.) / Rivet (24 nos.)  
(2 nos. of each Padlock eyes, Total 12 nos.)



Taj Loto - Right Angle Padlock Eye - Small / Medium / Large / Extra Large



**TL - BUFFER**  
Taj Loto-  
Metallic Buffer  
for Padlock Eye



**TL - RIVET**  
Taj Loto-  
Metallic Rivet  
for Padlock Eye



**TL - RIM**  
Taj Loto-  
Rivetting Machine  
weight : 165 gm



**TL - RPE - CAP**  
Taj Loto  
Flat Padlock Eye  
Cap

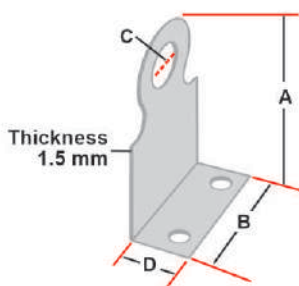

Dimension	TL-FPE-S	TL-FPE-M	TL-FPE-L	TL-FPE-XL	TL-RPE-S	TL-RPE-M	TL-RPE-L	TL-RPE-XL	TL-RPE-CAP
Height (A)	31 mm	48 mm	57 mm	71 mm	22 mm	38 mm	47 mm	60 mm	106 mm
Width (B)	25 mm	25 mm	25 mm	25 mm	25 mm	25 mm	25 mm	25 mm	65 mm
Hole Dia (C)	10 mm	10 mm	10 mm	10 mm	10 mm	10 mm	10 mm	10 mm	8 mm
Depth (D)					13 mm	13 mm	13 mm	13 mm	26 mm

## HANDY FOR LOCKOUT PADLOCK

- ☛ Ideal for employees who need to carry out multiple isolations. It helps in improving efficiency by keeping hands free. It holds up to 12 Safety Padlocks (in red colour).
- ☛ The Padlock handy is designed to be worn on the belt or can be hung on the wall / in the special cabinets, when not in use.



**TL - HANDY**  
Taj Loto - Handy  
for Lockout Padlock  
weight : 135 gm

**TL - HANDY + 12 SKP**  
Taj Loto - Handy with  
12 Same Key Padlock  
(in red colour)



## WALL MOUNTED MINI PADLOCK STATION

These wall mounting metallic powder coated padlock stations are supplied with screws.  
Available for 6, 12, 18 & 24 locks.  
Available in red colour as standard lockout practice.



**TL - MPS-12**  
Taj Loto - Wall Mounted Mini Padlock Station  
for 12 Padlocks



**TL - MPS-18**  
Taj Loto - Wall Mounted Mini Padlock Station  
for 18 Padlocks



**TL - MPS-6**  
Taj Loto - Wall Mounted  
Mini Padlock Station  
for 6 Padlocks



**TL - MPS-24**  
Taj Loto - Wall Mounted Mini Padlock Station  
for 24 Padlocks

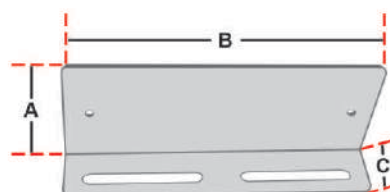

Dimension	TL-MPS-6	TL-MPS-12	TL-MPS-18	TL-MPS-24
Height (A)	70 mm	70 mm	70 mm	70 mm
Width (B)	130 mm	250 mm	370 mm	490 mm
Depth (c)	30 mm	30 mm	30 mm	30 mm

## ONE TIME USE HEART SHAPE PVC PADLOCK

- One time use and throw heart shape PVC padlock are generally given to the contractors / one time maintenance engineers - who just visit the facilities for once and for a specific job only and its mandatory for them too to follow the company's LockOut TagOut policies & procedure.
- Heart shape PVC padlock available in any colours (\*Conditions apply - minimum quantity 100 pieces in each colour instead of red) these PVC one time use padlocks are available with 6mm black Nylon Shackle.
- Standard colour is red.** Use hacksaw blade to cut shackle & remove this lock.

**TL - HSPP-R**  
Taj Loto - One Time Use  
Heart Shape PVC Padlock in Red colour



## ONE TIME USE WIRE PADLOCK SEAL

- One time use single push wire lock seals are used for single time lockouts.
- Available in the pack of 100 pieces and **Standard colour is red.**
- Use hacksaw blade to remove this seal.

**TL - WPS-R**  
Taj Loto - One Time Use  
Wire Padlock Seal in Red colour



## ONE TIME USE LOCK-TIE LOCKOUT



- LOCK-TIE are single time pull and lock seals used for one time lockout.
- 2mm diameter tail fits on the smallest sealing point.
- Manufactured from Polypropylene.
- Can be printed or supplied with printed labels with company details like logo / Lock-Tie no. / department name / location, etc.
- Available in pack of 100 pieces.
- Tie Length : 345mm Width: 2mm
- Standard colour is Red.**
- Use cutter to remove this seal.

**TL - LOCK-TIE - R**  
Taj Loto - One Time Use  
Lock-Tie Lockout in Red colour

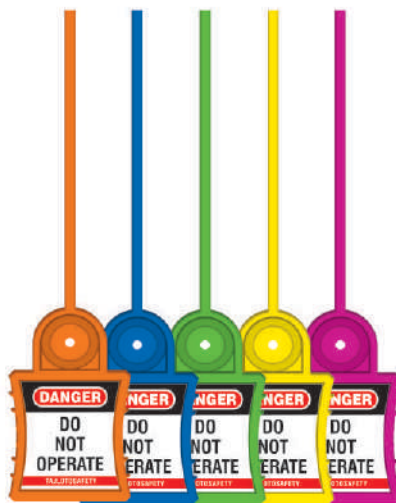

ONE TIME USE  
LOCKOUT PADLOCK SEAL

## TAJLOTO Lockout padlock seal has a plastic body and one time use product.



- Body Size : 16 x 30 x 10 mm
- Shackle Dia : 4 mm
- Brand Name : TAJ LOTO
- Model code : TL - OTU-LPS
- Material : ABS body + steel shackle with chrome finish
- Style : Sealing Strip
- Colors : Red, Yellow, White, Blue, Green, Orange etc.

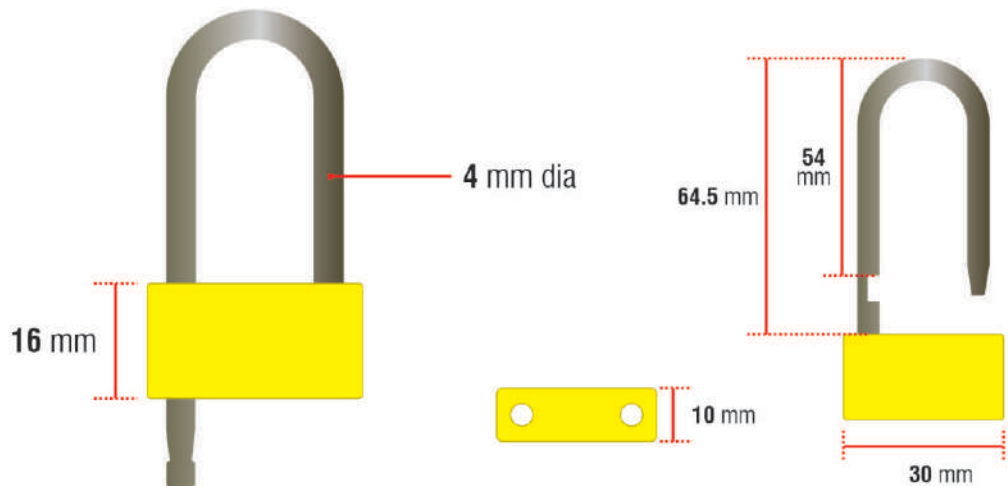

**TL - OTU-LPS**  
Taj Loto - One Time Use  
Lockout Padlock seal in Yellow colour

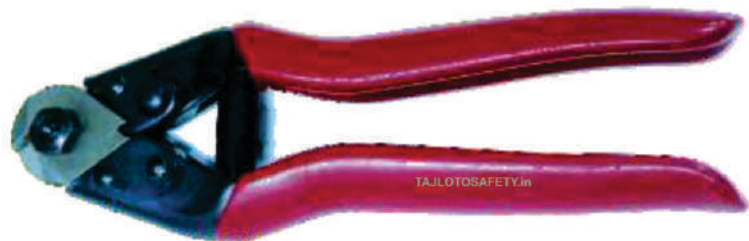

**TL - PLIER Cutter**  
TAJLOTO - PVC & Steel  
Padlock / Seal For  
Plier Cutter



## LOCKOUT HASP

*Safety lockout hasps allow multiple padlocks to be used when isolating one energy source. The lockout hasp is placed through the isolating point and closed. Every person carrying out maintenance or service work attaches and locks in place their own unique individually keyed padlock through the lockout hasp. This ensures each worker's safety as the energy cannot be restored until the work is finished and all padlocks have been removed. **We offer all kind of lockout hasps.***

DOMESTIC | [tajlotoindia@gmail.com](mailto:tajlotoindia@gmail.com)  
EXPORT | [tajlotoexport@gmail.com](mailto:tajlotoexport@gmail.com)



[tajlotosafety@gmail.com](mailto:tajlotosafety@gmail.com)  
[www.tajlotosafety.in](http://www.tajlotosafety.in)

## PVC COATED LOCKOUT HASP

- TAJ LOTO Hasps are available in 25 mm / 38 mm Dia Jaw size. In these hasps, the padlock fixing section is PVC coated for better gripping and visibility.
- Accepts padlocks with a shackle diameter up to 9 mm. 6 to 24 Padlock can be installed on each hasp; (depending on the holes provided).
- Hasps are manufactured from high tensile steel sheet which are electro-plated / powder coated to prevent rusting. In Yellow black hasps, Black Powder coating is done on steel.

**TL - PCH - S**  
Taj Loto  
PVC Coated Hasp - Small



**TL - PCH - S Y&B**  
Taj Loto - PVC Coated Hasp - Small  
Yellow & Black



**TL - PCH - S CR**  
Taj Loto - PVC Coated Hasp - Small  
Colour, Yellow / Blue / Green



**TL - PCH - P**  
Taj Loto  
PVC Coated Hasp - Premier



**TL - PCH - P Y&B**  
Taj Loto - PVC Coated Hasp - Premier  
Yellow & Black



**TL - PCH - P CR**  
Taj Loto - PVC Coated Hasp - Premier  
Colour, Yellow / Blue / Green



We can make according to your requirements **\*Minimum quantity Applicable**



Specification	TL - PCH - S	TL - PCH - P	TL - PCH - S Y&B	TL - PCH - P Y&B	TL - PCH - S CR	TL - PCH - P CR
Model	TL - PCH - S	TL - PCH - P	TL - PCH - S Y&B	TL - PCH - P Y&B	TL - PCH - S CR	TL - PCH - P CR
Material	Mild Steel	Mild Steel	Mild Steel	Mild Steel	Mild Steel	Mild Steel
Dia (Jaw Size)	25 mm	38 mm	25 mm	38 mm	25 mm	38 mm
Body width	39 mm	39 mm	39 mm	39 mm	39 mm	39 mm
Body height	114 mm	127 mm	114 mm	127 mm	114 mm	127 mm
Shackle Dia	9 mm	9 mm	9 mm	9 mm	9 mm	9 mm
Weight	98 gm	109 gm	98 gm	109 gm	98 gm	109 gm

## PVC COATED LOCKOUT HASP

- Hasps are manufactured from high tensile steel sheet and accepts padlocks with a shackle diameter up to 9 mm.
- 6 to 24 Padlock can be installed on each hasp; (depending on the holes provided).

**TL - PCH - 7H**  
Taj Loto - PVC Coated Hasp  
7 Hole



**TL - PCH - 12H**  
Taj Loto - PVC Coated Hasp  
12 Hole



**TL - PCH - 13H**  
Taj Loto - PVC Coated Hasp  
13 Hole



**TL - PCH - 24H**  
Taj Loto - PVC Coated Hasp  
24 Hole



Specification	TL - PCH - 7H	TL - PCH - 12H	TL - PCH - 13H	TL - PCH - 24H
Model	TL - PCH - 7H	TL - PCH - 12H	TL - PCH - 13H	TL - PCH - 24H
Material	Mild Steel	Mild Steel	Mild Steel	Mild Steel
Dia (Jaw Size)	25 mm	25 mm	25 mm	25 mm
Body width	39 mm	39 mm	39 mm	39 mm
Body height	129 mm	164 mm	171 mm	262 mm
Shackle Dia	8 mm	8 mm	8 mm	8 mm
Weight	8 gm	8 gm	8 gm	8 gm

*Customization Accepted*

We can make according to your requirements  
*\*Minimum quantity Applicable*

## ALUMINIUM PVC COATED LOCKOUT HASP



**TL - AH - 25 J**  
Taj Loto - Aluminium Hasp  
25mm Jaw Size



**TL - AH - 38 J**  
Taj Loto - Aluminium Hasp  
38mm Jaw Size



## ALUMINIUM LOCKOUT HASP FULL POWDER COATED

Non sparking full powder coated Aluminum Hasp are available for explosion hazard areas - offering added protection. Lightweight for easy use on electrical boxes, valves and control units.

**TL - AH-FPC - 25 J**  
Taj Loto - Aluminium Hasp  
Full Powder Coated  
25mm Jaw Size



**TL - AH-FPC - 38 J**  
Taj Loto - Aluminium Hasp  
Full Powder Coated  
38mm Jaw Size



## FULL POWDER COATED LOCKOUT HASP

are made from hardened steel sheets, duly powder coated in red colour.

**TL - FPC - LH - S**  
Taj Loto - Full Powder Coated  
Lockout Hasp - Small



**TL - FPC - LH - P**  
Taj Loto - Full Powder Coated  
Lockout Hasp - Premier



Specification						
Model	TL - AH - 25 J	TL - AH - 38 J	TL - AH-FPC - 25 J	TL - AH-FPC - 38 J	TL - FPC - LH - S	TL - FPC - LH - P
Material	Casted Aluminium	Casted Aluminium	Casted Aluminium	Casted Aluminium	Mild Steel	Mild Steel
Dia (Jaw Size)	25 mm	38 mm	25 mm	38 mm	25 mm	38 mm
Body width	39 mm	39 mm	39 mm	39 mm	39 mm	39 mm
Body height	114 mm	127 mm	113 mm	126 mm	113 mm	127 mm
Shackle Dia	9 mm	9 mm	9 mm	9 mm	9 mm	9 mm
Weight	38 gm	43 gm	35 gm	40 gm	95 gm	106 gm

## FULL POWDER COATED

**LOCKOUT HASP** are made from hardened steel sheets, duly powder coated in red colour.

**TL - FPC - LH - 7H**  
Taj Loto - Full Powder Coated  
Lockout Hasp - 7 Hole



**TL - FPC - LH - 12H**  
Taj Loto - Full Powder Coated  
Lockout Hasp - 12 Hole



**TL - FPC - LH - 13H**  
Taj Loto - Full Powder Coated  
Lockout Hasp - 13 Hole



**TL - FPC - LH - 24H**  
Taj Loto - Full Powder Coated  
Lockout Hasp - 24 Hole



Specification	TL - FPC - LH - 7H	TL - FPC - LH - 12H	TL - FPC - LH - 13H	TL - FPC - LH - 24H
Model	TL - FPC - LH - 7H	TL - FPC - LH - 12H	TL - FPC - LH - 13H	TL - FPC - LH - 24H
Material	Mild Steel	Mild Steel	Mild Steel	Mild Steel
Dia (Jaw Size)	25 mm	25 mm	25 mm	25 mm
Body width	38 mm	38 mm	38 mm	38 mm
Body height	128 mm	163 mm	170 mm	261 mm
Shackle Dia	9 mm	9 mm	9 mm	9 mm
Weight	9 gm	9 gm	9 gm	9 gm



We can make  
according to your  
requirements  
*\*Minimum quantity  
Applicable*

## STAINLESS STEEL HASP

are made as per internationally accepted designs. They are easy to use and acceptable at most of the isolation locking points.

- TL - PC SSH - S / P Hasps are made from 304 stainless steel sheet and have a sleek aluminium rivet. They are duly PVC coated at the padlock insert holes for better gripping. Accepts padlocks with a shackle diameter up to 9 mm.
- TL - SSH - 3S / 5S is manufactured from 304 stainless steel sheet with a bright nickle plated finished using mixed aluminum die casted insert. Ideal for use in all industrial environments.
- TL - FSSH - 3S / 5S is complete Stainless Steel piece with SS rivet. Accepts padlocks with a shackle diameter up to 8 mm.



**TL - PC SSH - S**  
Taj Loto - PVC Coated  
Stainless Steel Hasp - Small



**TL - PC SSH - P**  
Taj Loto - PVC Coated  
Stainless Steel Hasp - Premier



**TL - FSSH - 3S**  
Taj Loto - Full Stainless Steel  
Hasp - 3mm Shackle Dia



**TL - FSSH - 5S**  
Taj Loto - Full Stainless Steel  
Hasp - 5mm Shackle Dia

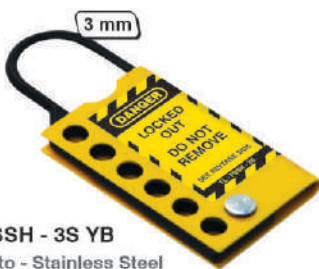

**TL - SSH - 3S YB**  
Taj Loto - Stainless Steel  
Hasp - 3mm Shackle Dia  
Yellow & Black



**TL - SSH - 5S YB**  
Taj Loto - Stainless Steel  
Hasp - 5mm Shackle Dia  
Yellow & Black



**TL - SSH - 5S**  
Taj Loto - Stainless Steel  
Hasp - 5mm Shackle Dia



We can make according to your requirements

\*Minimum quantity Applicable

### Specification

Model	TL - PC SSH - S	TL - PC SSH - P	TL - FSSH - 3S TL - FSSH - 5S	TL - SSH - 3S YB TL - SSH - 5S YB	TL - SSH - 3S TL - SSH - 5S
Material	Stainless Steel	Stainless Steel	Stainless Steel	Stainless Steel / Casted Aluminium	Stainless Steel / Casted Aluminium
Dia (Jaw Size)	25 mm	38 mm	35 x 25 mm	35 x 25 mm	35 x 25 mm
Body width	39 mm	39 mm	49 mm	49 mm	49 mm
Body height	114 mm	127 mm	116 mm	116 mm	116 mm
Shackle Dia	9 mm	9 mm	8 mm	8 mm	8 mm
Weight	106 gm	116 gm	95 / 100 gm	80 / 85 gm	80 / 85 gm

## STAINLESS STEEL TEMPER PROOF HEAVY DUTY HASP

TL - HDH Hasps (Heavy Duty Hasps) are made of marine grade 304 stainless steel. Fits to most of the switch gears & lockout gadgets with minimum 6.15 mm hole



**TL - SS HDH - 6 H**  
Taj Loto - Stainless Steel  
Heavy Duty Hasp - 6 Hole

Also available in 7 Hole



**TL - SS HDH - 13 H**  
Taj Loto - Stainless Steel  
Heavy Duty Hasp - 13 Hole



**TL - SS HDH - S**  
Taj Loto - Stainless Steel  
Heavy Duty Hasp - Small



**TL - SS HDH - P**  
Taj Loto - Stainless Steel  
Heavy Duty Hasp - Premier



**TL - SS HDH**  
Taj Loto - Stainless Steel  
Heavy Duty Hasp with 8 Hole



We can make according to your requirements

\*Minimum quantity Applicable

Specification	TL - SS HDH - 6 H	TL - SS HDH - 13 H	TL - SS HDH - S	TL - SS HDH - P	TL - SS HDH
Model	TL - SS HDH - 6 H	TL - SS HDH - 13 H	TL - SS HDH - S	TL - SS HDH - P	TL - SS HDH
Material	Stainless Steel	Stainless Steel	Stainless Steel	Stainless Steel	Stainless Steel
Dia (Jaw Size)	36 x 27 mm	36 x 27 mm	28 x 22 mm	74 x 22 mm	60 x 25 mm
Body width	59 mm	59 mm	62 mm	62 mm	44 mm
Body height	112 mm	153 mm	83 mm	172 mm	163 mm
Shackle Dia	5 mm	5 mm	6 mm	6 mm	4 mm
Weight	147 gm	187 gm	106 gm	193 gm	122 gm

## TAGO HASP

- ☛ TAGO HASP gives the benefits of a standard hasp & a tag simultaneously.
- ☛ Manufactured from aluminium sheet with red powder coated / Anodised\*. And Supply with warning label.
- ☛ Labels can be customized as per customer's requirement without any extra cost\* (minimum quantity applicable).

*\*for Anodised, minium quantity applicable.*

### TL - TAGO RED

Taj Loto - Tago Hasp Red Colour



### TL - TAGO-6HH GOLDEN

### TL - TAGO-6HH RED

Taj Loto - TAGO - 6 Hole Hasp - Golden / Red colours



**Customized Label**  
According to your requirement

### TL - TAGO RED 6H

Taj Loto  
Tago Hasp Red Colour 6 Hole



### TL - TAGO RED 8H

Taj Loto  
Tago Hasp Red Colour 8 Hole



### TL - TAGO RED 10H

Taj Loto  
Tago Hasp Red Colour 10 Hole



Specification					
Model	TAGO RED	TAGO - 6HH GOLDEN	TAGO RED 6H	TAGO RED 8H	TAGO RED 10H
Material	Aluminium	Aluminium	Aluminium	Aluminium	Aluminium
Dia (Jaw Size)	27 mm	27 mm	25 mm	25 mm	25 mm
Body width	77 mm	76 mm	75 mm	75 mm	75 mm
Body height	188 mm	188 mm	171 mm	171 mm	171 mm
Shackle Dia	8 mm	8 mm	8 mm	8 mm	8 mm
Weight	140 gm	140 gm	98 gm	96 gm	94 gm



## SCORPIO LOCKOUT HASP

Dual action hasp is a type of **SCORPIO lockout hasp** with different jaw sizes (45 mm & 20 mm of inner width) which adds to its versatility. This hasp is 5.35" inch in length and is made from mild steel. It accommodates up to 6 padlocks. It is available in plated steel or in Red powder coating to resist rust. The hasp has an aluminium rivet in between which provides a smooth movement.



**TL - RPC SCORPIO**  
Taj Loto  
Red Powder Coated  
Scorpio Hasp



Scorpio Hasp  
in open position



Specification	
Model	TL - RPC SCORPIO
Material	Mild Steel
Dia (Jaw Size)	(45 / 30) - (20 / 17)mm
Body width	37 mm
Body height	137 mm
Shackle Dia	10 mm
Weight	118 gm

## RED PREMIER HASP

Red Premier Hasp are **made of stainless steel & ABS material**. These can be locked using up to 4 padlocks. Available in 3 & 4 mm thick stainless steel shackle.



3 mm

**TL - RPH - 3**  
Taj Loto - Red Premier Hasp  
3mm Shackle



Red Premier Hasp  
in open position



4 mm

**TL - YPH - 4**  
Taj Loto - Yellow Premier Hasp  
4mm Shackle

Specification		
Model	TL - RPH - 3	TL - RPH - 4
Material	Stainless Steel / ABS	Stainless Steel / ABS
Dia (Jaw Size)	41 / 27 mm	40 / 26 mm
Body width	49 mm	49 mm
Body height	127 mm	128 mm
Shackle Dia	3 mm	4 mm
Weight	38 gm	42 gm

## DE - ELECTRIC SLIDER HASP

- De-Electric slider hasp with 4 hole, 3 & 6 mm shackle sizes.
- Available individually and in set of 2.
- De-Electric slider hasp made from Nylon / ABS.
- Highly visible with warning label.
- Best recommended for **ELECTRICAL PANELS, MCBs, etc.**



**TL - DESH 3S**  
Taj Loto  
De-Electric Slider Hasp  
3mm Shackle



**TL - DESH 6S**  
Taj Loto  
De-Electric Slider Hasp  
6mm Shackle

Slide Toggle Upwards



Open Position



Closed Position

Specification	TL - DESH - 3S	TL - DESH - 6S
Model	TL - DESH - 3S	TL - DESH - 6S
Material	Hard Nylon / ABS	Hard Nylon / ABS
Dia (Jaw Size)	47 / 25 mm	43 / 20 mm
Body width	61 mm	61 mm
Body height	108 mm	107 mm
Shackle Dia	3 mm	6 mm
Weight	33 gm	35 gm



We can make according to your requirements *\*Minimum quantity Applicable*

## DE-ELECTRIC FLEXIBLE LOCKOUT HASP

- Manufactured from flexible nylon with 45 & 80 mm clearance.
- Can easily be installed at different locations.
- Ideal for difficult applications. Accepts padlocks with a shackle diameter up to 8.5 mm.
- These hasps are tough, flexible, light weight and have additional benefit of being completely non-conductive.
- Ideal for Electrical Panels, MCBs, Switches & Panel Handles.**



**TL - E - FLH 33**  
Taj Loto - Electric Flexible Lockout Hasp  
3 Hole, 3mm Shackle



**TL - E - FLH 36**  
Taj Loto - Electric Flexible Lockout Hasp  
3 Hole, 6mm Shackle



**TL - E - FLH 66**  
Taj Loto - Electric - Flexible Lockout Hasp  
6 Hole, 6mm Shackle



**TL - E - FLH 65**  
Taj Loto - Electric Flexible Lockout Hasp  
6 Hole, 5.5mm Shackle



Available colours\*



Specification	TL - E - FLH 33	TL - E - FLH 36	TL - E - FLH 66	TL - E - FLH 65
Model	TL - E - FLH 33	TL - E - FLH 36	TL - E - FLH 66	TL - E - FLH 65
Material	Nylon	Nylon	Nylon	Nylon
Dia (Jaw Size)	53 / 24 mm	51 / 23 mm	86 / 25 mm	80 / 25 mm
Body width	40 mm	40 mm	42 mm	43 mm
Body height	112 mm	115 mm	195 mm	175 mm
Shackle Dia	3 mm	6 mm	6 mm	5.5 mm
Weight	16 gm	18 gm	29 gm	31 gm

**Customization Accepted**

We can make according to your requirements  
**\*Minimum quantity Applicable**



## CABLE LOCKOUT

*Cable lockouts are ideal for situations where there is a need to lockout multiple energy sources with one device or where the design / placement of the energy sources prevents other types of lockouts from being used.*

*Use the flexible cable to tie off the energy source. The device holds the cable firmly and prevents it from loosening. Several padlocks can be put on the device to ensure the safety of workers.*

*They are flexible, cost-effective, easy-to-use, just as efficient as chains but are much lighter and visible.*

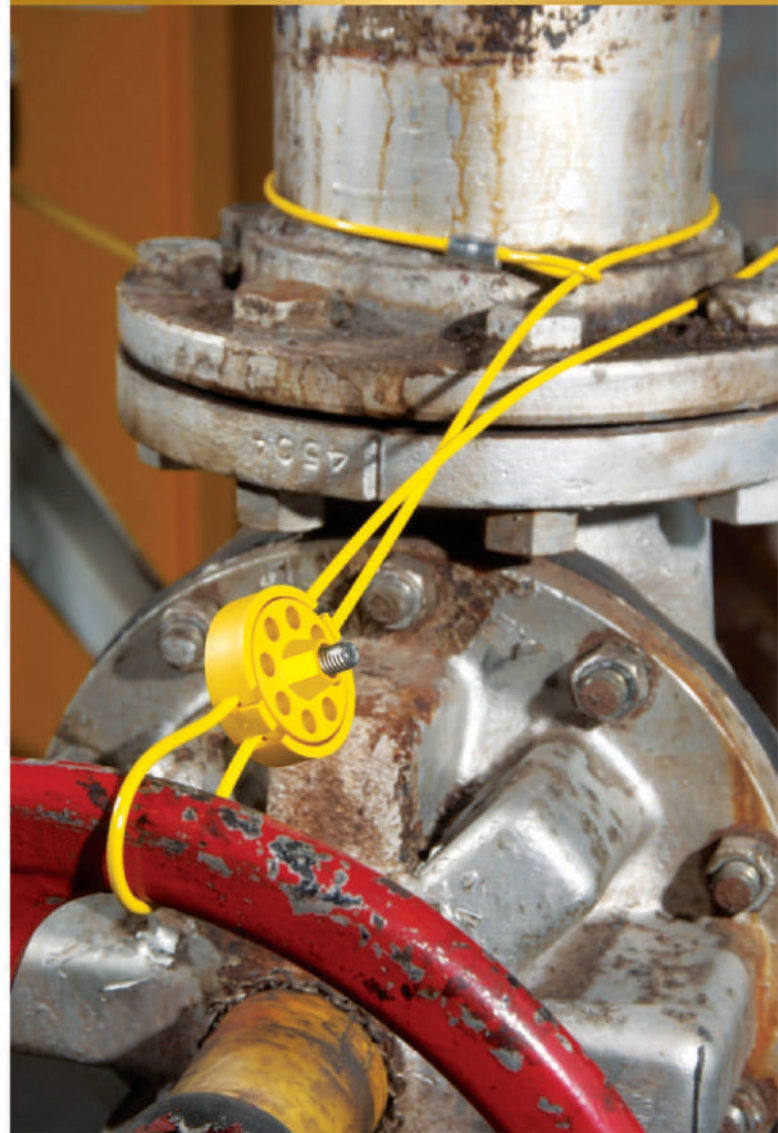

DOMESTIC | [tajlotoindia@gmail.com](mailto:tajlotoindia@gmail.com)  
EXPORT | [tajlotoexport@gmail.com](mailto:tajlotoexport@gmail.com)

[tajlotosafety@gmail.com](mailto:tajlotosafety@gmail.com)  
[www.tajlotosafety.in](http://www.tajlotosafety.in)

# CABLE LOCKOUT



**TAJLOTO SAFETY PVT. LTD.**  
LOCKOUT TAGOUT MANUFACTURER

## PREMIER CABLE LOCKOUT

- Can be used as a Hasp and Cable Lockout - Ideal for Multiple Applications.
- Scientifically made moulded section of PVC to befit human palm.
- Incorporating solid steel die cut insert for holding the looped vinyl coated galvanized steel cable at one point.
- Vinyl coated steel cable withstands more than 102 Kg weight.
- Additional 2 / 5 / 10 / 20 / 50 / 100 Mtrs. cable can be ordered separately.



**TL - PCL**  
Taj Loto  
Premier Cable Lockout  
Weight : 101



Steel Cable



**TL - PCL+2C L**  
Taj Loto  
Premier Cable Lockout with 2Mtrs.  
Vinyl Coated Steel Cable with Loop  
Weight : 101

## UNIVERSAL CABLE LOCKOUT

- This device is completely De-Electric, can be used in multiple applications. Scientifically made moulded section in PVC to hold 12 padlocks at any given time.
- Incorporating solid stainless steel inserts.
- It strongly hold's the vinyl coated galvanized steel cable in every environmental condition.
- Cable can withstand more than 102 Kg weight.
- Supplied with 2 Mtrs. cable of 4 mm thickness. Cable from 3 to 6 mm can be used with this device.

Top Side

Bottom Side



**TL - UCL**  
Taj Loto  
Universal Cable Lockout



**TL - UCL + 2C**  
Taj Loto - Universal Cable Lockout  
with 2mtrs. 4mm PVC Coated Steel Cable  
Weight : 101



Steel Cable

## SQUEEZER CABLE LOCKOUT

- ⚠ This Cable Lockouts are an excellent tool to tackle those difficult lockout situations. Made of ABS Plastic.
- ⚠ Generally supplied with 1mtr. steel cable (**Customized Cable lengths can be supplied against order**).
- ⚠ Route the cable - where necessary to lockout the device, then insert the cable from the top. When the cable is tight and the source is locked out, squeeze the handle and apply a padlock.
- ⚠ Available in Vinyl coated steel (**Blue**) cable and nylon DE-Electric (**Yellow**) cable versions for all kinds of locking.



**TL - SCL - MB**  
Taj Loto - Squeezing Cable Lockout  
with Metallic Blue Cable  
(Supplied with 1mtr. cable)  
Weight : 101



Steel Cable



**TL - SCL - DE - Y**  
Taj Loto - Squeezing Cable Lockout  
with De-Electric - Yellow Cable  
(Supplied with 1mtr. cable)  
Weight : 101



Nylon Cable



**TL - SCL - RB**  
Taj Loto - Squeezing Cable Lockout  
with Red & Black Combination  
(Supplied with 1mtr. cable)  
Weight : 101

Interlocking  
facility

- ⚠ Material – ABS Plastic.
- ⚠ Apply up to 5 padlocks.
- ⚠ Supply with 1 meter, 2 meter, 3 meter or 4 meter of cable.

## ECONOMY CABLE LOCKOUT

- ✦ Made of polypropylene.
- ✦ **Injection moulded** one set construction, comprising of **Stainless Steel nut and bolt** for corrosion free / long lasting working.
- ✦ Supplied with 2 Mtrs. Galvanized vinyl coated steel cable.
- ✦ Accepts 6 padlocks for numerous lockout applications. Withstands Temperatures (+55° C to -20° C).
- ✦ **Cable also available in 2 / 5 / 10 / 20 / 50 / 100 meter rolls.**

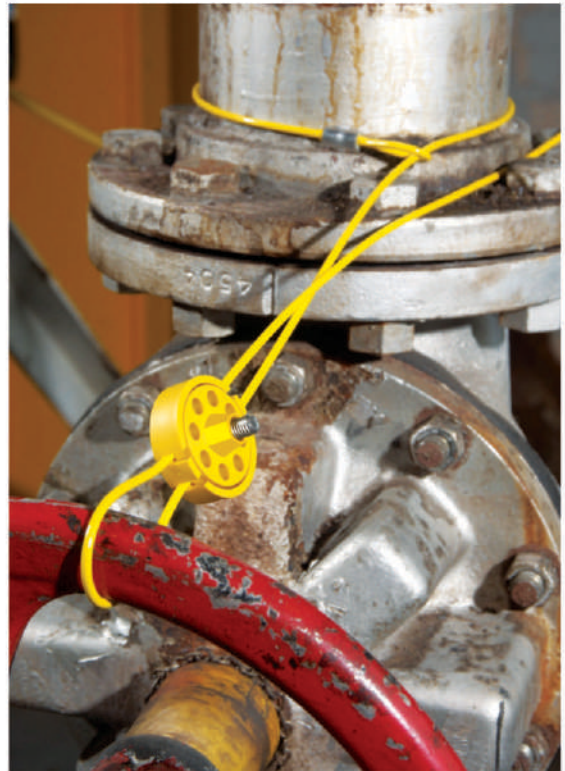

**TL - ECL-T+2C L**  
Taj Loto - Economy Cable Lockout + Tool  
with 2mtr. Vinyl Coated Steel Cable - with Loop  
Weight : 101



**TL - ECL**  
Taj Loto  
Economy Cable Lockout  
Weight : 101



**TL - ECL-T**  
Taj Loto - Economy Cable Lockout + Tool



**TL - ECL+2C WL**  
Taj Loto - Economy Cable Lockout  
with 2mtr. Vinyl Coated Steel Cable  
without Loop  
Weight : 101



**TL - ECL+2C L**  
Taj Loto - Economy Cable Lockout  
with 2mtr. Vinyl Coated Steel Cable  
with Loop  
Weight : 101

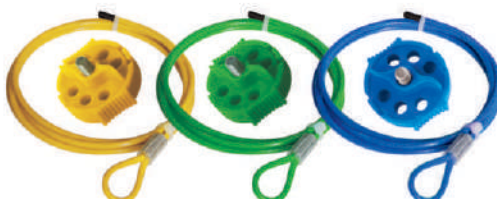

**TL - ECL+2C L Y/G/B/**  
Taj Loto - Economy Cable Lockout  
with 2mtrs. Vinyl Coated Steel Cable with Loop  
and Yellow / Green / Blue / colours



Steel Cable

## GRIP TYPE INTER LOCKABLE CABLE LOCKOUT

- ☛ Completely DE-Electric and used for Multiple applications.
- ☛ Scientifically made moulded section in PVC to hold 4 padlocks at any given time.
- ☛ Incorporating solid stainless steel inserts for holding the vinyl coated galvanized steel cable in any environment.
- ☛ Supplied with 2 / 5 meter cable of 3.5 mm thickness.
- ☛ Comes with **Interlocking facility** and brass tip of cable.



Interlocking facility

### TL - GTCL + 2C

Taj Loto - Grip Type - Cable Lockout with 2mtrs. Vinyl Coated Steel Cable  
Weight : 101

*(Extra Cable Length is available on order).*



Steel Cable



### TL - GTCL + 2C - Y/G/B

Taj Loto - Grip Type - Cable Lockout with 2mtrs. Vinyl Coated Steel Cable and Yellow / Green / Blue / colours



## 7 HOLE CABLE LOCKOUT

- Flexible, cost-effective cable lockout used to lock out multiple points.
- Lighter than chains, devices are easy to carry and use.
- Cable is made of steel with insulated cover.
- Standard Cable length is 2 Mtrs. (Extra Length is available on order).
- Supplied with loop.
- Made of ABS.



### TL - 7HCL

Taj Loto - 7 Hole Cable Lockout  
Weight : 101

### TL - 7HCL + 2C L

Taj Loto - 7 Hole Cable Lockout with 2mtrs. Vinyl Coated Steel Cable with Loop  
Weight : 101



Steel Cable

### TL - 7H HCL

Taj Loto - 7 Hole Hasp Lock Cable Lockout  
Weight : 101

### TL - 7H HCL + 2C L

Taj Loto - 7 Hole Hasp Lock Cable Lockout with 2mtrs. Vinyl Coated Steel Cable with Loop  
Weight : 101



## RAZOR LOOK CABLE LOCKOUT

- This multipurpose cable lockout device, uses a scissor action on the supplied cable. Supplied with 2 Mtrs. looped galvanized vinyl coated steel cable.
- A unique design, easy to handle - special grade hard PVC moulded one set construction - has provision for 4 locks. Extra cable of 5 / 10 Meter are available on request.
- Finger curves and thumb rest makes it easy to use.



### TL - RLCL

Taj Loto - Razor Look Cable Lockout  
Weight : 101

### TL - RLCL + 2C L

Taj Loto - Razor Look Cable Lockout with 2mtrs. Vinyl Coated Steel Cable with Loop  
Weight : 101



Steel Cable

## MOUSE LOOK CABLE LOCKOUT

This device is perfect for difficult lockout situations such as large gate valves or oversized devices. Simply route the cable through the lockout points and insert it back into the device, squeeze the black part to tighten the cable and insert the padlock.

Body is made of impact modified nylon. Mouse look cable lockout device comes with 2 Meters and 2 / 4 / 6 mm diameter cable. (5, 10 or 20 Meter cable can be ordered separately).



**TL - MLCL + 2C 4D**  
Taj Loto - MLCL  
with 2mtrs. and 4mm Dia  
Vinyl Coated Steel Cable

**TL - MLCL + 2C 2D**  
Taj Loto  
Mouse Look Cable Lockout  
with 2mtrs and 2mm Dia  
Vinyl Coated Steel Cable

**TL - MLCL + 2C 6D**  
Taj Loto - MLCL  
with 2mtrs. and 6mm Dia  
Vinyl Coated Steel Cable



## ECONOMY BRASS CABLE LOCKOUT

- ⚠ Product made of Brass and stainless steel cable (non corrosive).
- ⚠ Device consists of 2 meter long, stainless steel cable with the locking device.
- ⚠ Once fitted, the cable is clamped using tamper-proof screw with the special key provided.

**TL - EBCL+2SSC**  
Taj Loto - Economy Brass  
Cable Lockout with 2 Mtrs.  
Stainless Steel Cable  
Weight : 101



## METALLIC MULTIPURPOSE CABLE LOCKOUT

- Best for Outdoors - Corrosive & Harsh Industrial Environment.
- Specially Moulded, Metallic construction comprising of Stainless Steel nut for corrosion free / long lasting working.
- 4 piece Moulded set, Easy to install and lockout.
- Open ended Stainless Steel cable is used with MMCL.
- Stainless steel **cable has to be ordered as required, in 2 / 5 or 10 meter lengths.**
- Most suitable for locking large size gate valves of all types.
- Totally dependable, Worldwide appreciated design.



**TL - MMCL**

Taj Loto - Metallic Multipurpose  
Cable Lockout  
Weight : 101



**TL - MMCL + 2 SSC**

Taj Loto - Metallic Multipurpose  
Cable Lockout with 2mtrs.  
Stainless Steel Cable  
Weight : 101



**TL - 2SSC for MMCL**

Taj Loto - 2mtrs.  
Stainless Steel Cable for  
Metallic Multipurpose  
Cable Lockout  
Weight : 101

**TL - 5SSC for MMCL**

Taj Loto - 5mtrs.  
Stainless Steel Cable for  
Metallic Multipurpose  
Cable Lockout  
Weight : 101

## STAINLESS STEEL / VINYL COATED STEEL / DE ELECTRIC CABLES

### WITH OR WITHOUT LOOP

For LOCKOUT purpose, some time small or large cables are required in Vinyl coated steel / Stainless Steel / De-electrical cables with or without the loops.

You can be ordered in any lengths from **1 feet to 200 meters**.

Vinyl coated steel cables are mostly available in Red colour.

*You can be ordered  
in any lengths from  
1 feet to 200 meters.*



**TL - SSC WL**

Taj Loto - Stainless Steel Cable  
Without Loop

**TL - SSC OSL**

Taj Loto - Stainless Steel Cable  
with One Side Loop

**TL - SSC BSL**

Taj Loto - Stainless Steel Cable  
with Both Side Loop



**TL - VSC OSL**

Taj Loto - Vinyl Coated Steel Cable  
with One Side Loop

**TL - VSC BSL**

Taj Loto - Vinyl Coated Steel Cable  
with Both Side Loop

**TL - VSC WL**

Taj Loto - Vinyl Coated Steel Cable  
Without Loop



**TL - VDEC BSL**

Taj Loto - Vinyl Coated De-Electric Cable  
with Both Side Loop

**TL - VDEC OSL**

Taj Loto - Vinyl Coated De-Electric Cable  
with One Side Loop

**TL - VDEC WL**

Taj Loto - Vinyl Coated De-Electric Cable  
Without Loop



## VALVE LOCKOUT

*Valve lockouts are simple and effective in order to prevent unauthorized operation of valves. Valves come in a huge range of shapes, sizes and methods of operation. Whether you have Ball Valves, Gate Valves, Plug Valves, Globe Valves or Butterfly Valves; their method of operation determine the lockout device for the valve.*

*Several valves are manually operated via a handwheel / lever / wrench or the valve might be power actuated e.g. electric motor, hydraulic or pneumatic actuator. Regardless of the method of operation, all valves can be locked out by our various available lockout solutions.*



DOMESTIC | [tajlotoindia@gmail.com](mailto:tajlotoindia@gmail.com)  
EXPORT | [tajlotoexport@gmail.com](mailto:tajlotoexport@gmail.com)

[tajlotosafety@gmail.com](mailto:tajlotosafety@gmail.com)  
[www.tajlotosafety.in](http://www.tajlotosafety.in)

## GATE VALVE LOCKOUT

- ⚠ Virtually indestructible valve covers.
- ⚠ Once locked, they rotate freely around the hand wheel & prevent the valve wheel from being turned.
- ⚠ The strong polyurethane plastics make them resistant to cracking and abrasion.
- ⚠ They are resistant to extreme weather and temperature conditions.
- ⚠ Available in 5 sizes ( Red colour ) Other colours are available on request (*minimum quantity applicable*)\*.
- ⚠ Padlock holes are available in each gate valve lockout device.
- ⚠ Withstands temperatures from - 20°F to 200°F.
- ⚠ Unique knockout center accommodates OS & Y or "rising stem" valves.
- ⚠ Hasps and padlocks can be used to lock these lockouts.



- ◀ TL - GVL - 10
- ◀ TL - GVL - 8
- ◀ TL - GVL - 6
- ◀ TL - GVL - 4
- ◀ TL - GVL - 2

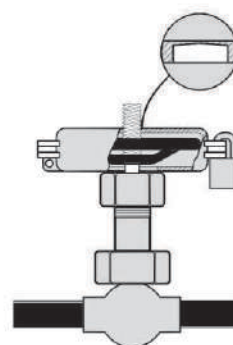
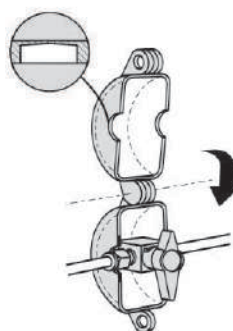

**Make a cutout with sharp blade for accommodating rising spindle stem valves**

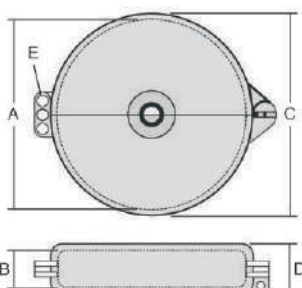

Specification	TL - GVL - 2	TL - GVL - 4	TL - GVL - 6	TL - GVL - 8	TL - GVL - 10
<b>Model</b>	TL - GVL - 2	TL - GVL - 4	TL - GVL - 6	TL - GVL - 8	TL - GVL - 10
<b>Material</b>	polyurethane plastics	polyurethane plastics	polyurethane plastics	polyurethane plastics	polyurethane plastics
<b>Fit in Gate Valve handle wheel dia</b>	25 - 63.5 mm (1" - 2.5")	63.5-127 mm (2.5" - 5")	127-165 mm (5" - 6.5")	165-254 mm (6.5" - 10")	254-355 mm (10" - 13")
<b>Inside Dia (A)</b>	70 mm	130 mm	170 mm	257 mm	355 mm
<b>Inside Depth (B)</b>	32 mm	34 mm	41 mm	50 mm	63 mm
<b>Outside Dia (C)</b>	76 mm	140 mm	177 mm	267 mm	368 mm
<b>Outside Height (D)</b>	38 mm	44 mm	50 mm	63 mm	74 mm
<b>Weight</b>	50 gm	185 gm	285 gm	675 gm	1120 gm

## GATE VALVE ADJUSTABLE LOCKOUT

- It adjusts to fit gate valves from 25 to 165 mm (1" to 6.5" gate valve hand wheels).
- Covers and rotates freely around the valve's wheel.
- Made of durable ABS Plastic.
- Resistant to extreme temperature changes - 13°F to +194°F.
- Compact design for easy carrying and storage.



**TL - GVAL**  
Taj Loto - Gate Valve Adjustable Lockout

Available colours\* 

Specification	
Model	TL - GVAL
Material	ABS Plastic
Fit in Gate Valve handle wheel dia	25 - 165 mm (1" - 6.5")
Weight	

## BUTTERFLY VALVE LOCKOUT

When slid into position, the wedge on the slider section prevents the compression handle from being squeezed, preventing operation of the valve. Padlock is placed through the holes to ensure proper lockout. Hasps maybe used when multiple locking is required.

- Designed to lock most kinds of butterfly valves in the industries.
- Resistant to cracking and abrasion. Highly resistant to solvent and other chemical products.
- Available in 4 colours, \*minium quantity required.
- Made of durable ABS Plastic.
- They are resistant to extreme weather and temperature conditions making them suitable for outdoors.



Available colours\* 



**TL - BFVL**  
Taj Loto - Butterfly Valve Lockout  
Weight : 285 gm

## BALL VALVE LOCKOUT

- These easy to use lockouts, clamp over the valve lever - preventing the valve from being operated. **BVL-1 & BVL-2 can lock the small sized valves in both open or closed positions**, whilst the larger **BVL-1 EX & BVL-3L & 4L can only be used in the closed position.**
- These two piece, moulded lockouts can be installed on most of the ball valves available internationally.
- They are virtually indestructible. Inner slider is used for gripping the valve handle sleeves inside the cover.
- Once locked, they prevent valve handle from being turned.
- The strong polyurethane plastic make them resistant to cracking and abrasion.
- They are resistant to extreme weather & temperature conditions.
- Non conductive. Available in 4 colours;\* minimum quantity required.



**TL - BVL - 1**  
Taj Loto - Ball Valve Lockout - 1  
in Side Locking Provision



**TL - BVL - 2**  
Taj Loto - Ball Valve Lockout - 2  
in Top Locking Provision



**TL - BVL-1 EX**  
Taj Loto - Ball Valve Lockout - 1  
Extended in Side Locking Provision



**TL - BVL - 3 L**  
Taj Loto -  
Ball Valve Lockout - 3 Large  
in Top Locking Provision



**TL - BVL - 4 L**  
Taj Loto -  
Ball Valve Lockout - 4 Large  
in Side Locking Provision

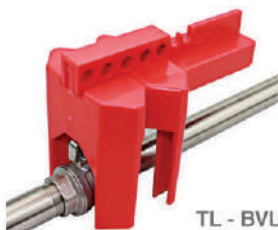

**TL - BVL - 2**

### Specification

Model	TL - BVL - 1	TL - BVL-1 EX	TL - BVL - 2	TL - BVL - 3 L	TL - BVL - 4 L
Material	Polypropylene Copolymer (PPcp) Plastic	Polypropylene Copolymer (PPcp) Plastic	Polypropylene Copolymer (PPcp) Plastic	Polypropylene Copolymer (PPcp) Plastic	Polypropylene Copolymer (PPcp) Plastic
For Ball Valve Pipe Dia	9.5 - 31.75 mm (0.375" - 1.25")	38 - 63.5 mm (1.5" - 2.5")	12.5 - 31 mm (0.5" - 1.25")	50 - 200 mm (2" - 8")	50 - 200 mm (2" - 8")
Max Handle length	7.5"	10"	8"	Large Size	Large Size
Weight	165 gm	247 gm	145 gm	630 gm	598 gm

## STANDARD BALL VALVE LOCKOUT

- ⚙ This lockout lock quarter-turn ball valves in OFF position.
- ⚙ They virtually fit on valve levers up to 76 mm wide.
- ⚙ **TL - S-S BVL** & **TL - S-L BVL** are manufactured by steel with red powder coated.



**TL - S - S BVL**  
Taj Loto - Standard  
Small - Ball Valve Lockout



**TL - S - L BVL**  
Taj Loto - Standard  
Large - Ball Valve Lockout



Specification		
<b>Model</b>	<b>TL - S - S BVL</b>	<b>TL - S - L BVL</b>
<b>Material</b>	Steel with powder coated	Steel with powder coated
<b>Max Shackle Dia</b>	0.375" (9.5mm)	0.281"
<b>Pipe Dia</b>	0.25" - 1" (6.3 - 25mm)	1.25" - 3" (31.75 - 75mm)
<b>Max Handle Width</b>	1.5" (38mm)	2.125" (54mm)
<b>Max Handle Thickness</b>	0.75" (19mm)	2.75" (69.8mm)
<b>Weight</b>		

## SETTABLE BALL VALVE LOCKOUT

- Used for precise Locking & closing / opening of the ball valves of various sizes and makes.
- Constructed from **super tough nylon** and **stainless steel** to avoid corrosion. Designed to lock out quarter-turn valves of varying sizes and geometric handle dimensions (round, square or flat) up to 1.25" thick x 1.625" wide and various lengths. Valves can also be locked in the ON or fixed positions for non lockout applications. To freeze the valve handle at an exact location attach the second Arm (Sold separately) to lock handle of 2 / 3 / 4 or 5 way Valves.
- Ideal for all kinds of usage areas / pipelines like gaseous, oils, liquids, air pressure pipes & valves etc.**



**TL - SSBVL - SET (Small)**  
Taj Loto - Small Size Settable Ball Valve Lockout - with Small Arm

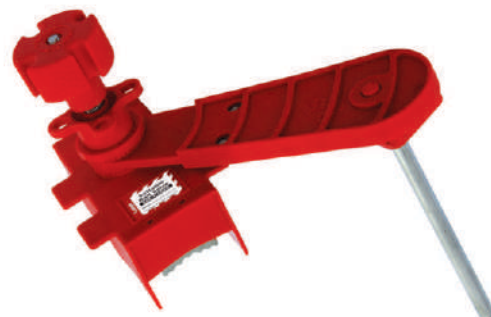

**TL - LSBVL - SET (Large)**  
Taj Loto - Large Size Settable Ball Valve Lockout - with Large Arm



**TL - Small - Arm**  
Taj Loto - Small Arm  
(with 4.5" Stainless Steel Rod)



**TL - Large - Arm**  
Taj Loto - Large Arm  
(with 5.75" Stainless Steel Rod)



**TL - Small - Arm Ex**  
Taj Loto - Small Arm Extended  
(with 8.75" Stainless Steel Rod)



**TL - Large - Arm Ex**  
Taj Loto - Large Arm Extended  
(with 10.25" Stainless Steel Rod)

## UNIVERSAL VALVE CABLE LOCKOUT

**TL - UVL**  
Taj Loto -  
Universal Valve Lockout.



*Use as a Butterfly Valve Lockout*



*Use as a Ball Valve Lockout*

Use two locking arms to lockout 3 / 4 or 5-way valves or to lock valves in the throttled position for operational control.

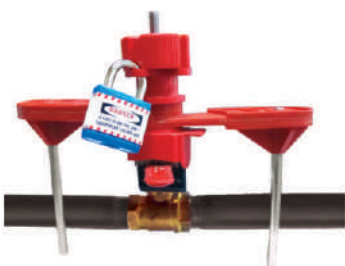

**TL - UVL + 2SA**  
Taj Loto - Universal Valve Lockout  
with 2 Small Arm

- ⚡ Versatile, rugged, easy to use, lightweight and chemical resistant lockout device.
- ⚡ It's open ended clamp fits over closed rings, wide handles and large levers, T-handles and other hard-to-secure mechanical devices.
- ⚡ Use two blocking arms to lock out 3 / 4 / 5 way valves.
- ⚡ Injection moulded - **special ABS grade / stainless steel** components embedded Lockout.
- ⚡ The clamp attaches to the butterfly valve lever, preventing the trigger handle from being squeezed.
- ⚡ Multiple functioning with the help of vinyl coated steel cable and arms.
- ⚡ Use cable attachment to lockout gate valves.
- ⚡ Made from industrial grade stainless steel and nylon for rugged durability; giving chemical and corrosion resistance.
- ⚡ This Universal Lockout is a modular construction which allows the user to add various accessories to make the device suitable for a large range of valves.
- ⚡ Arms are available in different Stainless Steel Rod lengths / sizes.



**TL - UVL + 2C**  
Taj Loto - Universal Valve Lockout  
with 2 Mtrs. Galvanized Steel Cable



**TL - UVL + 2C + LA**  
Taj Loto - Universal Valve Lockout  
with 2 Mtrs. Galvanized Steel Cable  
and Large Arm



**TL - UVL + LA**  
Taj Loto - Universal Valve Lockout  
with Large Arm



**TL - UVL + SA**  
Taj Loto - Universal Valve Lockout  
with Small Arm

**TL - UVL + 2LA**  
Taj Loto - Universal Valve Lockout  
with 2 Large Arm

**\* Extended Small & Extended Large Arms also available.**

## UNIVERSAL BUTTERFLY VALVE LOCKOUT



**TL - UBFVL - Y**  
Taj Loto - Universal Butterfly Valve Lockout in Yellow Colour



**TL - UBFVL - R**  
Taj Loto - Universal Butterfly Valve Lockout in Red Colour

- ✦ This lockout device jams the valve lever release trigger. (Place **UBFVL** between the valve lever and release trigger & hinge open until the two parts jack the valve lever and release trigger to a frizzed position). Use a **TL- GTCL + 2C** cable lockout to secure the device in place by passing the cable around the valve body and through the matching hole of **UBFVL**. Place the padlocks on **GTCL** and secure the device.
- ✦ This product is also known as butterfly valve handle jammer. Available in **Red & Yellow** colours.
- ✦ The complete set is **TL- UBFVL + GTCL** which comprises of the lockout device with cable lockout.
- ✦ Manufactured by **special grade nylon**.



**TL - UBFVL + GTCL+2C**  
Taj Loto - Universal Butterfly Valve Lockout with Gun Type Cable Lockout and 2mtrs. Vinyl Coated steel Cable





## CYLINDER LOCKOUT

*These adjustable lockout devices are used to lockout cylinders containing dangerous materials, thus preventing unauthorized use.*

*These cylinder device Installed in seconds and provides quick and easy identification of a full / empty cylinder.*



DOMESTIC | [tajlotoindia@gmail.com](mailto:tajlotoindia@gmail.com)  
EXPORT | [tajlotoexport@gmail.com](mailto:tajlotoexport@gmail.com)

[tajlotosafety@gmail.com](mailto:tajlotosafety@gmail.com)  
[www.tajlotosafety.in](http://www.tajlotosafety.in)

## GATE VALVE CYLINDER LOCKOUT

- Designed with stem hole dia of 29 mm, **made of Polypropylene (PP) plastic.**
- Prevents access to the valve handle.
- Easy application.
- Used to lockout propane cylinders on Forklift trucks.
- Designed to fit in tight spaces. Single padlock can be applied.



**TL - GVCL**  
Taj Loto - Gate Valve Cylinder Lockout



## CYLINDER LOCKOUT

- Made of Polypropylene (PP) plastic.**
- Easy application. Prevent access to the valve handle.
- The unit encloses the valve head and is locked in place with two interlocking plates.
- Installed in seconds and provides quick and easy identification of a full / empty cylinder. Additional function of applying a padlock to lock the device in place, to prevent unauthorized activation of the valve.
- Inner size - 85 mm dia x 150 mm depth.
- Designed with the stem hole dia of 35 mm.



**TL - CL - CY**  
Taj Loto - Cylinder Lockout Complete Yellow



**TL - CL - CR**  
Taj Loto - Cylinder Lockout Complete Red



**TL - CL - Full**  
Taj Loto - Cylinder Lockout Full



**TL - CL - Empty**  
Taj Loto - Cylinder Lockout Empty



**3 Hole Interlocking**  
cylinder lockout cover



**TL - VCL + ECL**  
Taj Loto - Valve Cylinder Lockout + Economy Cable Lockout with 3 Mtrs. Cable



**TL - Cust. CL - CY**  
Taj Loto - Customized Cylinder Lockout Complete Yellow



## PNEUMATIC LOCKOUT

*Isolate pneumatic energy without the expense and inconvenience of installing in-line lockout valves. These quick connectable lockouts are applied to the male fittings, isolating equipment from all compressed air sources.*

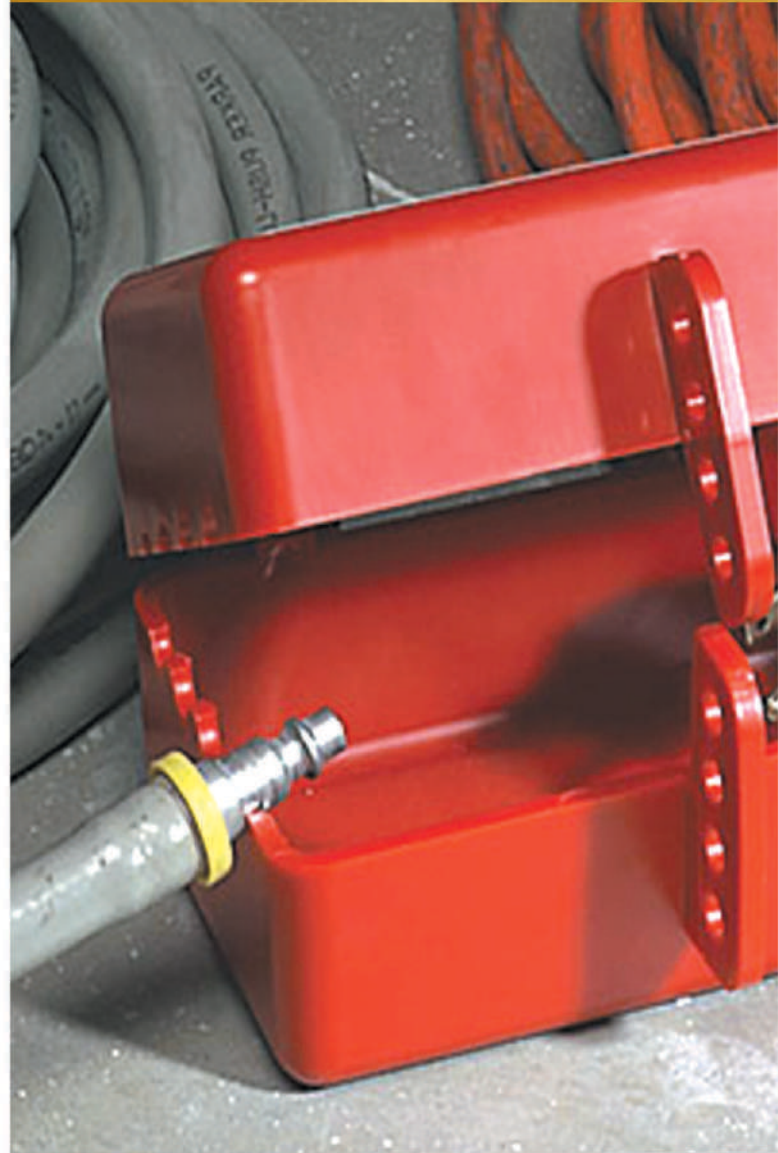

DOMESTIC | [tajlotoindia@gmail.com](mailto:tajlotoindia@gmail.com)  
EXPORT | [tajlotoexport@gmail.com](mailto:tajlotoexport@gmail.com)

[tajlotosafety@gmail.com](mailto:tajlotosafety@gmail.com)  
[www.tajlotosafety.in](http://www.tajlotosafety.in)

## PNEUMATIC LOCKOUT BOX

- Accommodates male air hose connectors as well as their electrical plugs (110 V, 220 V, 550 V Plugs).
- Made of ABS material; 4 padlocks can be applied.**
- Ensures that the male air hose connectors & the plug can't be used until the lock is removed.



**TL - LPL**  
Taj Loto - Large Pneumatic Lockout



**TL - SPL**  
Taj Loto - Small Pneumatic Lockout

## PNEUMATIC LOCKOUT

- This uniquely designed pneumatic lockout fits virtually on all pneumatic fittings used in manufacturing facilities. The pneumatic lockout is applied to the fitting to prevent it from being reconnected to the pressurized air source.
- Manufactured by solid Stainless Steel sheets** - to make them strong, durable and resistant to corrosion.
- Easy to use, just place over the male fittings between the two parts and apply your lockout padlock.

Hole Sizes (mm dia.)

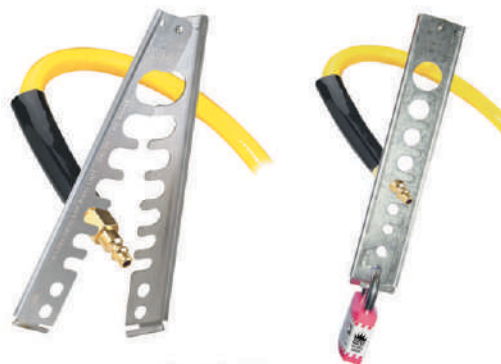
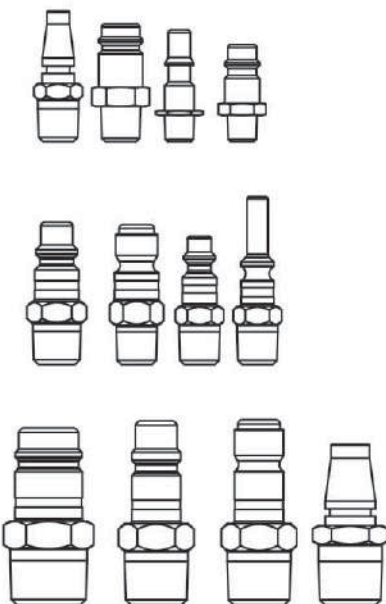
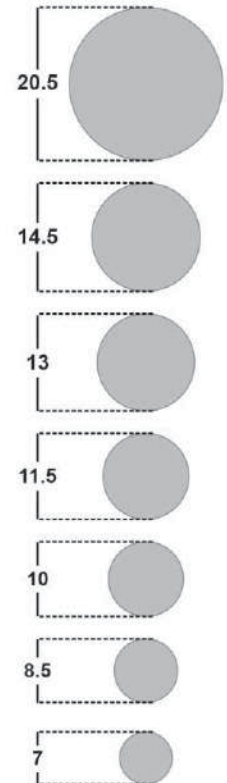

**TL - PL 9 H**  
Taj Loto - Pneumatic Lockout Straight with 9 Holes



## PLUG LOCKOUT

Plug lockout prevent electrical plugs from being inserted into a wall outlet. It is used when the plug is not under the exclusive control of the person performing service or maintenance.



DOMESTIC | [tajlotoindia@gmail.com](mailto:tajlotoindia@gmail.com)  
EXPORT | [tajlotoexport@gmail.com](mailto:tajlotoexport@gmail.com)

[tajlotosafety@gmail.com](mailto:tajlotosafety@gmail.com)  
[www.tajlotosafety.in](http://www.tajlotosafety.in)

## ELECTRICAL PLUG LOCKOUT BOX TYPE

**Made of ABS plastic**, these units have been developed to completely enclose electrical plugs to prevent a machine from being energized. The plug completely sits inside the unit with the cable being fed through an access hole.

The small unit is suitable for a variety of electrical connections up to 40 mm diameter, with a locking mechanism that can accommodate up to 4 safety padlocks.

The large unit is suitable for standard and larger electrical plugs, including 3 phase connectors.

- ⚡ Plug lockout prevents electrical plugs from being inserted into a wall outlet.
- ⚡ Small 110V plug lockout : 80 H x 44 D x 42 W mm with 0.5" diameter hole for cable.
- ⚡ Large 220V / 500V plug lockout : 155 H x 86 D x 84 W mm with 8.5 to 19 diameter holes for cable.
- ⚡ Completely encloses electrical plugs to prevent accidental re-connection.



**TL - SPLO**  
Taj Loto - Small Plug Lockout



**TL - LPLO**  
Taj Loto - Large Plug Lockout



OPEN VIEW

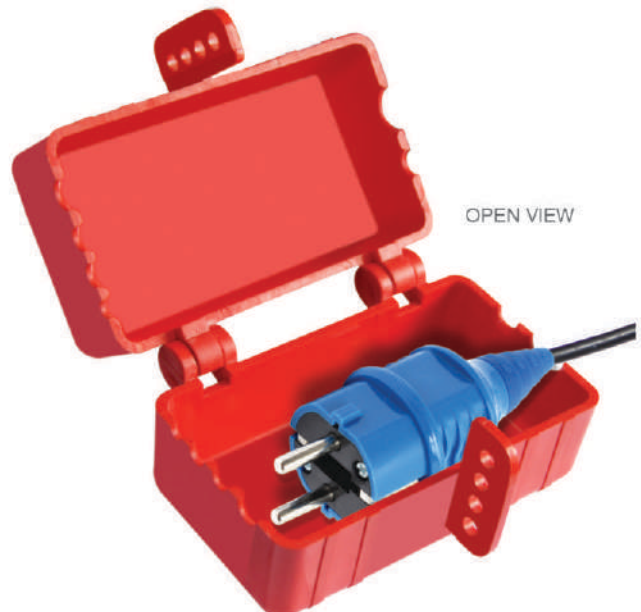

OPEN VIEW

## ELECTRICAL PLUG LOCKOUT PREMIER

Made of **ABS plastic**, these units have been developed to completely enclose electrical plugs to prevent a machine from being energized. The plug completely sits inside the unit with the cable being fed through an access hole.

The small unit is suitable for a variety of electrical connections up to 40 mm diameter, with a locking mechanism that can accommodate up to 4 safety padlocks.

The large unit is suitable for standard and larger electrical plugs, including 3 phase connectors.

- ⚠ Plug lockout prevents electrical plugs from being inserted into a wall outlet.
- ⚠ Small 110V plug lockout : 2" H x 2" D x 3.5" W with 0.5" inch diameter hole for cable.
- ⚠ Large 220V / 500V plug lockout : 3.25" H x 3.25" D x 7" W with 1" inch diameter hole for cable.
- ⚠ Completely encloses electrical plugs to prevent accidental re-connection.



**TL - SPLO - P**  
Taj Loto -  
Small Plug Lockout - Premier



**TL - LPLO - P**  
Taj Loto -  
Large Plug Lockout - Premier

## CYLINDER ELECTRICAL PLUG LOCKOUT

- ⚠ Unique device prevents plugs from being 'plugged in' until intentionally removed.
- ⚠ Slip plug into the chemical-resistant (**polypropylene**) plastic cylinder, close one or both cover plates for a snug fit and secure with Padlock.
- ⚠ Fits any plug up to 600 volts, 5.875" x 3" inch dia.
- ⚠ Lockout devices are supplied with instructions.

**TL - CE - PL**  
Taj Loto - Cylinder Electrical  
Plug Lockout



## PLUG COVER LOCKOUT

- These Small and Large Plug Cover Lockouts are made of special grade non tearable red fabric & black leather encased belt.
- They can be supplied on request with solid **PVC pipe insert**, of suitable dia to avoid unwanted operation of the control buttons of hoist of cranes etc. (at an extra cost)



**TL - SPCL - R**  
Taj Loto-  
Small Plug Cover Lockout - Red



**TL - LPCL - R**  
Taj Loto-  
Large Plug Cover Lockout - Red



Using pipe is most recommended to avoid any intentional operation of switches.



**TL - SPCL + P**  
Taj Loto-  
Small Plug Cover Lockout - with Pipe

**TL - LPCL + P**  
Taj Loto-  
Large Plug Cover Lockout - with Pipe

Dimension				
Model	TL - SPCL-R	TL - LPCL-R	TL - SPCL + P	TL - LPCL + P
Width	9" inch	9" inch	9" inch	9" inch
Length	18" inch	25" inch	18" inch	25" inch
Pipe Dia			5" inch	5" inch
Pipe Length			12" inch	20" inch

## PLUG LOCKOUT FOR PIN & SLEEVE

This device is insert to the **MALE PLUG** and it holds the extruded portion of the plug.

Apply Isolation procedure sequence no. A, B, & C  
For **PLUG LOCKOUT**

Made of Polycarbonate (PC) plastics.



Lockout Point

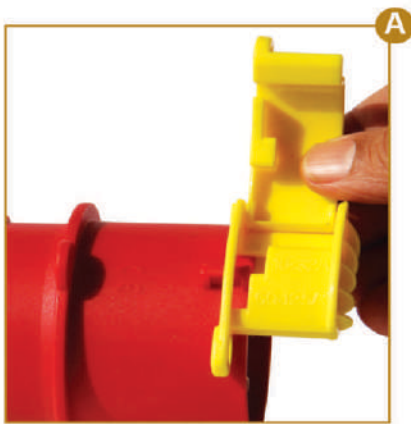

TL - PL P&S  
TajLoto - Plug Lockout  
FOR Pin & Sleeve

**One product  
for all sizes of plugs.**

## SOKET LOCKOUT FOR PIN & SLEEVE

This device is inserted directly into the **FEMALE SOCKET**. Then used Hasp & Padlock on the female socket flap & Provision hole of the socket Device

Apply Isolation Procedure sequence no. A, B, C &, D For **SOCKET LOCKOUT**

Made of Polycarbonate (PC) plastics.



54 mm Ø

**TL - SL P&S - S**

**TajLoto - Socket Lockut For  
Pin & Sleeve Small**



68 mm Ø

**TL - SL P&S - M**

**TajLoto - Socket Lockut For  
Pin & Sleeve Medium**

Ø - Outer Dia

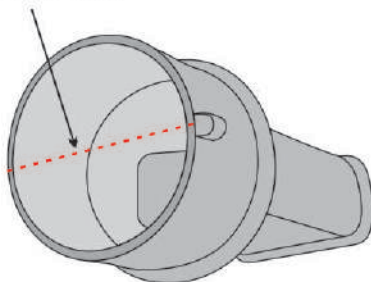

78 mm Ø

**TL - SL P&S - L**

**TajLoto - Socket Lockut For  
Pin & Sleeve Large**

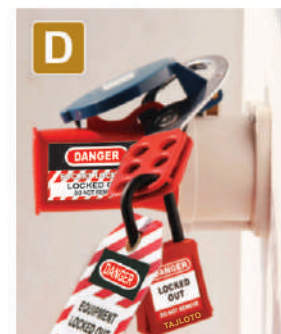



## CIRCUIT BREAKER LOCKOUT

*As per OSHA, all energy sources should be turned off and locked out to protect employees from injuries caused by the accidental startup of equipment under repair and service. To aid in complying with OSHA 1910.147, we offer a complete range of high quality, universal Circuit Breaker Lockout Devices to ensure that electrical energy sources are isolated for optimal work place safety. These Circuit Breaker Lockouts are part of an extensive line of innovative safety devices designed by professionals to protect employees from risks associated with hazardous energy, while meeting safety and regulatory requirements.*

DOMESTIC | [tajlotoindia@gmail.com](mailto:tajlotoindia@gmail.com)  
EXPORT | [tajlotoexport@gmail.com](mailto:tajlotoexport@gmail.com)



[tajlotosafety@gmail.com](mailto:tajlotosafety@gmail.com)  
[www.tajlotosafety.in](http://www.tajlotosafety.in)

## MINI CIRCUIT BREAKER LOCKOUT

- Safe & Effective method for locking out Mini Circuit Breakers.
- Push Button / Slider type Mini CBL - does not require any tool for installation.
- The Tie Bar style lockout has a convenient thumb wheel for quick application on multiple breakers.
- Can be applied on single / multiple breakers.
- A Padlock should be applied on these lockout devices.
- Made of ABS, Nylon body. And pins made of stainless steel.

The first three devices in each range work by engaging wire pins into small holes located on either side of the MCB switch toggle. In order to engage the pins into the holes, they have to be exposed further. On the **Standard Type**, this is achieved by pressing the spring loaded black colour plunger with the thumb. In the **Slider Type** the upper part of CBL is pulled back for releasing the pins & pushed back for locking purpose.

The **Tie Bar** & Mini **CBL** offers a degree of universality. Both can be used on multi-pole breakers which are operated with a tie-bar. Mini **CBL** is fixed to the breaker using a small screw driver.

### STANDARD TYPE



**TL - PIN IN CBL**  
TajLoto - PIN IN Standard Circuit Breaker Lockout



**TL - PIN OUT CBL**  
TajLoto - PIN OUT Standard Circuit Breaker Lockout



**TL - PIN OUT WIDE CBL**  
TajLoto - PIN OUT WIDE Standard Circuit Breaker Lockout



**TL - TIE BAR CBL**  
TajLoto - TIE BAR Standard Circuit Breaker Lockout

**TL - COMBO CBL - 3**  
TajLoto - 1 Piece each of Pin In, Pin Out, Pin Out Wide Standard CBL

**TL - COMBO CBL - 4**  
TajLoto - 1 Piece each of Pin In, Pin Out, Pin Out Wide & Tie Bar Standard CBL



\*In case Standard or Slider CBL are not usable on Circuit Breakers, installed individually / together / multi-pole, etc. Use our TL-UMCBL-GT.



**TL - UMCBL - GT**  
Taj Loto - Universal Mini Circuit Breaker Lockout Grip Type

### SLIDER TYPE



**TL - PIN IN SCBL**  
TajLoto - PIN IN Slider Circuit Breaker Lockout



**TL - PIN OUT SCBL**  
TajLoto - PIN OUT Slider Circuit Breaker Lockout



**TL - PIN OUT WIDE SCBL**  
TajLoto - PIN OUT WIDE Slider Circuit Breaker Lockout



**TL - MCBL - R**  
TajLoto - Mini Circuit Breaker Lockout - Red

**TL - COMBO SCBL - 3**  
TajLoto - 1 Piece each of Pin In, Pin Out, Pin Out Wide Slider CBL

**TL - COMBO SCBL - 4**  
TajLoto - 1 Piece each of Pin In, Pin Out, Pin Out Wide & MCBL-R, Slider CBL

Made of ABS plastic. And pins made of stainless steel.

Made of ABS plastic embedded with brass ferrule.

## MINI CIRCUIT BREAKER LOCKOUT (COMBO SET OF 5)

- Safe & effective method for locking out Mini Circuit Breakers.
- These lockouts can easily be installed with the aid of a screw driver.
- The Brass ferrule gives extra life and strength to all plastics made lockouts & strengthen the grip of internal screw.
- They can be used on single & multi - pole breakers.
- A padlock should be applied on them to lockout the MCBs.
- **TL- MCBL-Y, TL- MCBL-GS, TL- UMCBL-B, and TL- UMCBL-GT** all made of ABS plastic embedded with brass ferrule and supply with stainless steel screw for installation.
- **TL- UBCBL** is made of nylon plastic body embedded with brass ferrule and supply with stainless steel screw for installation.



**TL - MCBL - Y**  
TajLoto - Mini  
Circuit Breaker Lockout  
Yellow



**TL - MCBL - GS**  
TajLoto - Mini  
Circuit Breaker Lockout  
Green Siemens



**TL - UMCBL - B**  
TajLoto - Universal Mini  
Circuit Breaker Lockout - Blue



**TL - UMCBL - GT**  
TajLoto - Universal Mini  
Circuit Breaker Lockout  
Grip Type



**TL - UBCBL**  
TajLoto - Universal Big Size  
Circuit Breaker Lockout

### TL - COMBO Set of 5

Taj Loto - Combo Circuit Breaker Lockout  
(Set of 5) 1 piece of each TL-MCBL-Y,  
TL-MCBL-GS, TL-UMCBL-B,  
TL-UMCBL-GT and TL-UBCBL



**TL - SD FCBL**  
TajLoto - Screwdriver for  
Circuit Breaker Lockout

*All our circuit breaker lockouts have brass threaded inner for perfect running of screw for a very long time.*



# CIRCUIT BREAKER LOCKOUT



**TAJLOTO SAFETY PVT. LTD.**  
LOCKOUT TAGOUT MANUFACTURER

## MINI CIRCUIT BREAKER LOCKOUT UNIVERSAL TYPE

Always use Lockout tagout when you work on electrical equipment.

Safe & easy method for locking out Mini Circuit Breakers Universal type lockout. These Mini UCBL - does not require any tool for installation and can be applied on single / multiple breakers.

Made of Polystyrene (PS) plastic. And pins made of stainless steel.

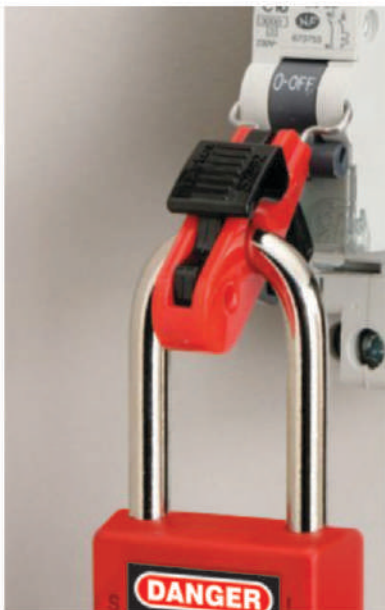

### Easy method of installation :

- ✦ Firstly, Place the circuit breaker switch in the OFF position.
- ✦ Locate the small holes in the center of the miniature circuit breaker switch toggle.
- ✦ Pull the black part of the universal CBL, Press both front red parts and insert pin into the small holes of miniature circuit breaker switch toggle.
- ✦ After the pin goes into the small hole of miniature circuit breaker switch, push the black part down and apply the padlock on the device.



**TL - PIN IN UCBL**  
TajLoto - PIN IN Universal Type Circuit Breaker Lockout

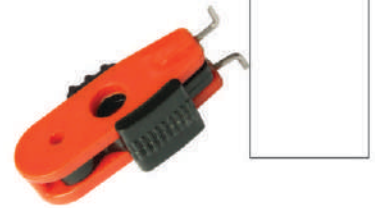

**TL - PIN OUT UCBL**  
TajLoto - PIN OUT Universal Type Circuit Breaker Lockout



**TL - PIN OUT WIDE UCBL**  
TajLoto - PIN OUT WIDE Universal Type Circuit Breaker Lockout

## MINI CIRCUIT BREAKER LOCKOUT for Schneider MCB

- ✦ Mini circuit breaker lockout made of ABS Plastic material and Lock hole diameter 6mm.
- ✦ This Lockout device does not required any tool for installation.
- ✦ Apply this device only on Schneider MCB.

### Easy method of installation :

- ✦ Slide up gently the device part and insert the pin into the circuit breaker holes then slide down for lockout.
- ✦ Apply the Taj Loto Padlock and tag on the provided hole into the device.



**TL - PL SMCB**  
TajLoto - PIN Lockout for Schneider MCB



## UNIVERSAL CIRCUIT BREAKER LOCKOUT



- ⚡ Safe & effective method for locking out Circuit Breakers (MCB's & MCCB's).
- ⚡ These lockout devices can easily be installed with the aid of a screw driver or with the help of Twister Screw. (Standard Pointed Type)
- ⚡ It can be used on single & multi - pole breakers.
- ⚡ A padlock on UCBL should be applied to lockout the MCBs.
- ⚡ Made of ABS plastic embedded with brass ferrule. And screws made of stainless steel.

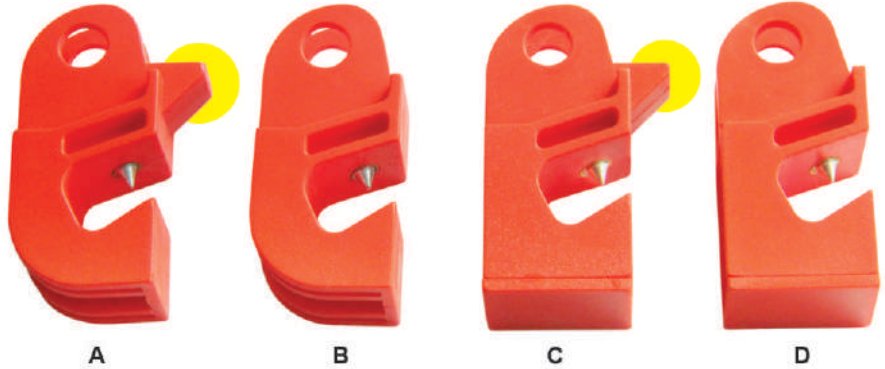

A

B

C

D

### TL - UCBL

TajLoto - Universal Circuit Breaker Lockout (A / B / C / D /)  
ORDER INDIVIDUALLY

### TL - UCBL COMBO

TajLoto - Universal Circuit Breaker Lockout  
Set of one each of A / B / C / D /



Back &  
Top side of  
UCBL - C & D



**TL - UCBL - A TS**  
TajLoto - Universal  
Circuit Breaker Lockout  
A Tail Type with Twister Screw



**TL - UCBL - B TS**  
TajLoto - Universal  
Circuit Breaker Lockout  
B Type with Twister Screw



**Flat & Pointed Screws** are  
available for these Circuit  
Breaker Lockouts.

**Kindly mention  
at the time of ordering.**



**Brass threaded insert**  
is used for smooth  
operation of screw.

# CIRCUIT BREAKER LOCKOUT

## MINI CIRCUIT BREAKER LOCKOUT TWISTER SCREW



*Brass threaded insert is used for smooth operation of screw*

- ⚡ Safe & effective method for locking out Mini Circuit Breakers without a screw driver.
- ⚡ They can be used on single & multi - pole breakers.
- ⚡ A padlock should be applied on them to lockout the MCBs.
- ⚡ Made of ABS plastic embedded with brass ferrule. And screws made of stainless steel.



**TL - MCBL - Y TS**  
TajLoto - Mini  
Circuit Breaker Lockout  
Yellow with Twister Screw



**TL - MCBL - YU TS**  
TajLoto - Mini  
Circuit Breaker Lockout  
Yellow Universal with Twister Screw



**TL - MCBL - YS TS**  
TajLoto - Mini  
Circuit Breaker Lockout  
Yellow Siemens with Twister Screw

## EUROPA MINI CIRCUIT BREAKER LOCKOUT



Nylon MCB Lock, the Europa MCB lock fits most modern breakers. Locks MCBs, RCBOs, RCCBs, and Main switch Isolator, Merlin Gerin MG 26970 for C60 mini circuit breaker in the ON or OFF Positions. The device has wire clips which engage behind the toggle of the circuit breaker. Once fitted the padlocking device can be secured in place with a safety padlock (not included).

Made of ABS body. And pins made of stainless steel.



**TL - EU MCBL - Y**  
TajLoto - Europa Mini  
Circuit Breaker Lockout  
Yellow



**TL - EU MCBL - R**  
TajLoto - Europa Mini  
Circuit Breaker Lockout  
Red

## UNIVERSAL GOLDEN TOGGLE MCB LOCKOUT

- ⚡ *This is simplest yet most versatile MCB lockout in our range.*
- ⚡ The UNIVERSAL GOLDEN TOGGLE LOCK fits over most of the MCB switch toggles and is secured in place using a small flat blade screwdriver to turn the grub screw.
- ⚡ Once tight & secure, insert your Padlock / Hasp that blocks access to the grub screw, so that the device could not be removed until the lock is removed.
- ⚡ It is made of aluminum. And crews made of stainless steel.



**TL - UGT - MCBL**  
TajLoto - Universal Golden Toggle Mini Circuit Breaker Lockout

## UNIVERSAL 2-IN-1 CIRCUIT BREAKER LOCKOUT

- ⚡ Designed to fit most MCBs and main switches. Our **Universal 2-IN-1 CBL** is ideal for use on domestic and industrial applications.
- ⚡ Extra length clearance on the toggle side allows the device to be used on breakers with extra long toggles, as well as the standard size.
- ⚡ Thicker main switches are accommodated on the opposite side making this 2-in-1 device truly multi-functional in today's market.
- ⚡ It is made of from Great Electrical Insulation Properties ABS (Acrylonitrile butadiene styrene) plastic embedded with brass ferrule. And screws made of stainless steel.

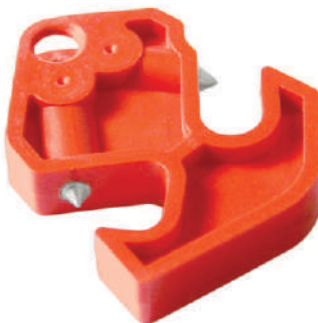

**TL - U2-IN-1 CBL**  
TajLoto - Universal 2-IN-1 Circuit Breaker Lockout



*Brass threaded insert is used for smooth operation of screw.*



## LARGE CIRCUIT BREAKER LOCKOUT

- ☛ Locks out a wide range of three phase Circuit Breakers (227 V & above).
- ☛ Fits on lever of Circuit Breaker upto 3" wide & 0.9" thick.
- ☛ Made of ABS plastic. And screws made of stainless steel.
- ☛ Corrosion resistant.
- ☛ Easy installation : simply turn the screw into the circuit breaker handle & add your own Padlock and Tag after fitting it properly.



**TL - LCB**  
TajLoto - Large Circuit Breaker Lockout



**TL - LCB - TS**  
TajLoto - Large Circuit Breaker Lockout  
with Twister Screw



**TL - LCB - R**  
TajLoto - Large Circuit Breaker Lockout  
with Round Handle



**Brass threaded insert  
is used for smooth  
operation of screw.**

## CLAMP-ON BREAKER LOCKOUT



- ⚡ Extremely versatile - works on wide range of single-pole and internal-trip multi-pole breakers.
- ⚡ Three sizes available, for 120 / 277 V breakers & for 480 / 600 V. The large lockout fits on breaker switches up to 2 1 / 4" wide and 7 / 8" thick.
- ⚡ made of nylon body embedded with brass ferrule. And screw made of stainless steel.
- ⚡ Use twister screw to clamp lockout securely onto switch tongue, then pull cover over thumbscrew and lock in place to prevent clamp from being loosened.
- ⚡ Detachable cleats (included) expand the range of applicable breakers.
- ⚡ Accepts locks shackles up to 7.5 mm in diameter.



**TL - COBL - S**  
TajLoto - Clamp-on  
Breaker Lockout - Small  
(for 120 / 277 V Breakers)



**TL - C / COBL - S**  
TajLoto - Cleat for Small  
Clamp-on Breaker Lockout

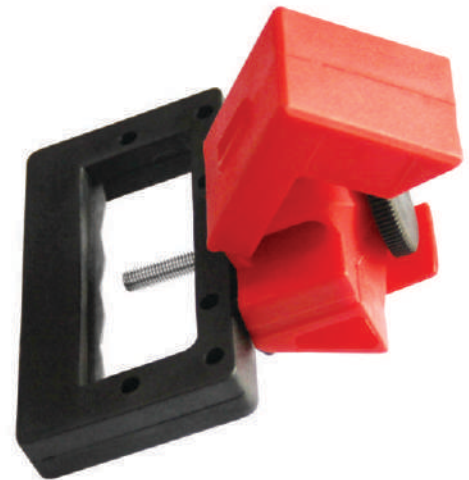

**TL - COBL - Large**  
TajLoto - Clamp-on Breaker Lockout - Large  
(Fits on breaker switches up to 2 1 / 4" wide and 7 / 8" thick)



**TL - COBL - M**  
TajLoto - Clamp-on  
Breaker Lockout - Medium  
(for 480 / 600 V Breakers)



**TL - C / COBL - M**  
TajLoto - Cleat for Medium  
Clamp-on Breaker Lockout

**TL - COMBO COBL**  
Taj Loto - Combo Clamp-on Breaker Lockout  
(1 Piece each of all the COBL  
(Small, Medium & Large + 2 Cleats)



**Brass threaded insert  
is used for smooth  
operation of screw.**

## BREAKER LOCKOUT



**TL - TS-SPBL**  
TajLoto - Top Slide -  
Single Pole Breaker Lockout



**TL - MPBL**  
TajLoto - Multi Pole  
Breaker Lockout



**TL - SPBL**  
TajLoto - Single Pole  
Breaker Lockout

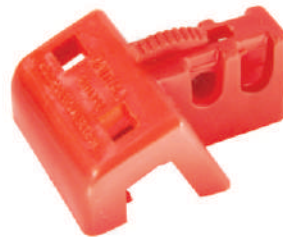

**TL - DPL-L**  
TajLoto - Double Pole  
Lockout for Large Breaker

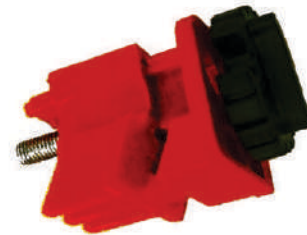

**TL - UMP-BL**  
TajLoto - Universal Multi Pole -  
Breaker Lockout

- ⚠ **TL - TS-SPBL** : This lockout fits right into the switch. Mount in place over "off" position switch and secure with a padlock. Fits most major brand, single-pole breakers. Made of ABS plastic.
- ⚠ **TL - MPBL** : Circuit breaker for voltage 120 / 277, requires the breakers to be connected with a cross bar. Made of ABS plastic.
- ⚠ **TL - SPBL** : A single pole lockout that does not require a switch breaker with a recessed hole in it.
  - Circuit breaker lockouts are *made of ABS* material and are quick and easy to apply. "No Hole" Circuit Breaker Lockout is designed to fit circuit breaker toggles up to 1/2" wide without a recess hole in the toggle.
- ⚠ **TL - DPL-L** : A double pole lockout, similar to **MPBL** but slightly larger to accommodate larger breakers. This circuit breaker lockout is now available for either single or double pole circuit breaker lockout applications. Made of ABS plastic.
- ⚠ **TL - UMP-BL** : This clamp-on type circuit breaker lockout is a single device that can be used with most major multi-pole breakers that employ a tie bar. Easy to use, *It is made from durable glass-filled nylon, polypropylene (PP) with a stainless steel screw.* This versatile device is compatible with most of the branded manufacturers, such as GE, ITE, Sylvania, Cutler-Hammer, Challenger, Bryant, Siemens, Square D and General Switch Company. 120/ 277 VOLTS
- ⚠ **To use, just secure the clamp lockout over the tie bar by tightening the thumbscrew and insert padlock to prevent the clamp from being loosened.**

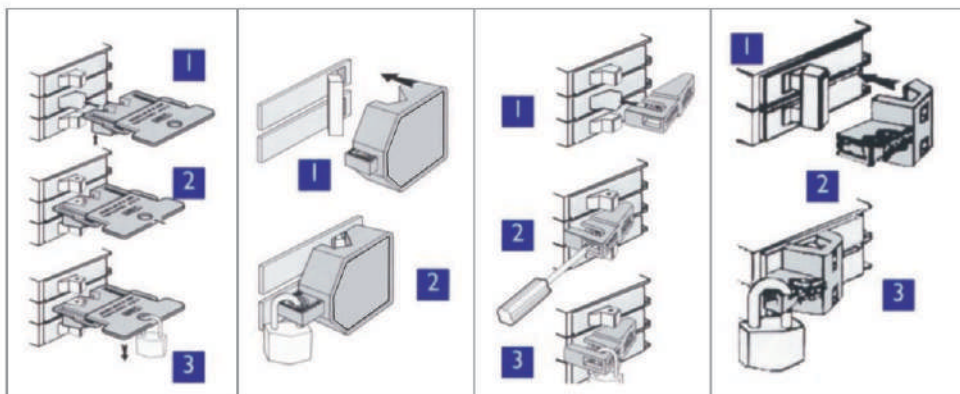

## TOOL FREE UNIVERSAL CIRCUIT BREAKER LOCKOUT



*Flat & Pointed Screws* are available for these TF-CBL & TF-UCBL Lockouts. Kindly mention at the time of ordering.

Specially designed to be **used on electrical MCBs & MCCBs**. Fixation with a thumb twister screw for fast and easy installation. Special construction in thermoplastic (ABS) material resistant to chemicals. Withstand extreme environmental conditions. Since twister stainless steel screw is hidden under the cover, it prevents removal of **TF-UCBL**.

Safety padlock / lockout hasps of up to 6 mm can be applied horizontally or vertically.

**Both pointed & flat screws are supplied with each piece.**



**TL - TF CBL**  
TajLoto - Tool Free Circuit Breaker Lockout



**TL - TF UCBL**  
TajLoto - Tool Free Universal Circuit Breaker Lockout

**TL - TF COMBO**  
TajLoto - Tool Free Combo Universal Circuit Breaker Lockout (Set of 2, 1 piece of TF-CBL & TF-UCBL)



*Brass threaded insert is used for smooth operation of screw.*

## TIGHT GRIP CIRCUIT BREAKER LOCKOUT



*Brass threaded insert is used for smooth operation of screw.*

Small one fits standard height and tie-bar toggles typically found on 120 and 240 volt breakers & bigger one fits on wide / tall breaker toggles typically found on hi-voltage / hi-ampere breakers. Universal fit exclusive design accommodates many styles of breaker toggles.

Adjust to breaker with simple thumb turn and then close clamping handle for a tight grip on the toggle, Secure mounting for a solid lockout. Compact design, the narrow profile permits side-by-side breaker lockout.

Durable construction, The Tight Grip lockouts are made of ABS, nylon to operate in harsh conditions.



**TL - TG CBL - S**  
TajLoto - Tight Grip Circuit Breaker Lockout Small

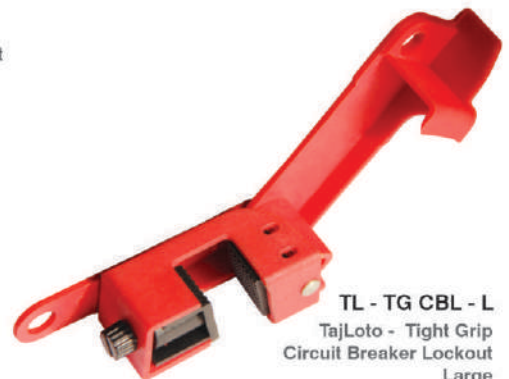

**TL - TG CBL - L**  
TajLoto - Tight Grip Circuit Breaker Lockout Large

**TL - TG CBL COMBO**  
TajLoto - Tight Grip Circuit Breaker Lockout Combo 1 Piece each of TG CBL - S & L

## TWO SIDE BLACK MG TOGGLE HASP

- Two Side **Merlin Gerin** Padlocking Hasp.
- Merlin Gerin Powerpact 4c Toggle Padlocking Attachment.
- This device engages in the slot behind the switch toggle, blocking its operation. Adding a padlock prevents unauthorized operation and secures the device in place when the breaker is in the OFF position.
- This device made of stainless steel with black color powder coated.

Installed easily in 3 - steps

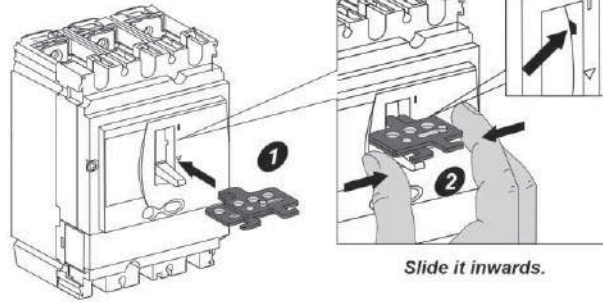

Switch of the MCCB & Insert the "TOGGLE HASP".



TL - TS TH

TajLoto - Two Side Toggle Hasp

Slide it inwards.

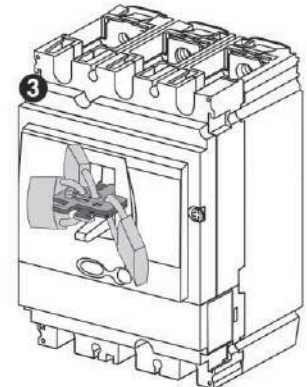

Place the Locks in the matching holes.

## MOLDED CASE CIRCUIT BREAKER LOCKOUT FOR ABB

- This is applied to the T1 - T2 - T3 / **FUJI** molded case circuit breaker cover to prevent the lever closing or opening operation. It allows installation up to a maximum of 3 padlocks of around 7mm shackle dia.
- Plug-in locking device only for the closing operation.
- This device made of stainless steel with red color powder coated.



TL - MCCBL  
TajLoto - Molded Case  
Circuit Breaker Lockout for ABB

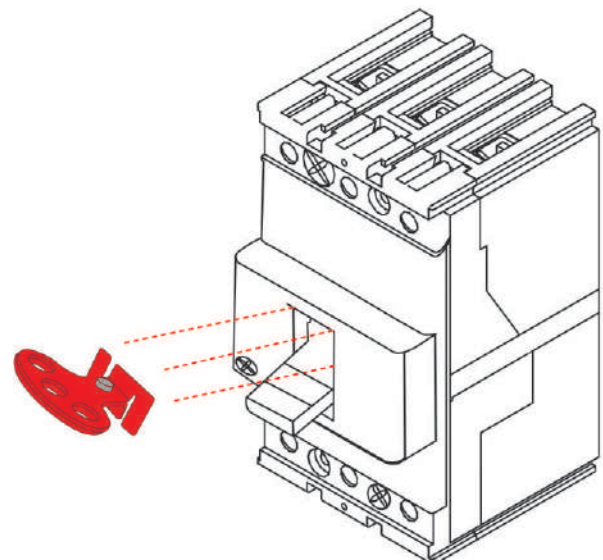

## SNAP-ON CIRCUIT BREAKER LOCKOUT

- Designed for 120V breakers that have holes in the switch tongue.
- Quick and easy - just snap in place and apply lock.
- Dual cavities accommodate different size switch tongues.
- TL - SOCBL - P** : This device is made of a flexible, durable Nylon plastic.
- TL - SOCBL** : This device is made of ABS plastic. And screws is made of stainless steel.

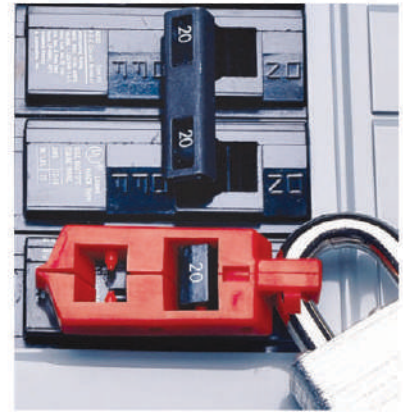

**TL - SOCBL - P**  
TajLoto - Snap-on  
Circuit Breaker Lockout - Premier



**TL - SOCBL**  
TajLoto - Snap-on  
Circuit Breaker Lockout.



*Brass threaded insert is used for smooth operation of screw.*

## WALL SWITCH LOCKOUT

- Device to be used to lockout wall-mounted switches.
- Easy to install using existing screws.
- High visibility red color.
- Locks switch in "on" or "off" position.
- Made of red color Polypropylene (PP), uses existing wall plate screws to mount.
- Hinge & Non - hinge pattern.



**TL - WSL**  
TajLoto -  
Wall Switch Lockout



**TL - WSL - TH**  
TajLoto - Wall Switch Lockout  
Top Hinge



## ABB CIRCUIT BREAKER LOCKOUT

- ⚡ Locking device for RCCBs
- ⚡ For securing single or multi-pole RCCBs against unauthorised switching on or off. Install direct padlock or use 3 / 6 mm de-electric hasp.
- ⚡ Made of ABS, Nylon body. And pins made of stainless steel.



**TL - ABB CBL**  
TajLoto - ABB - Circuit Breaker Lockout

## COMPUTER / POWER CORD LOCKOUT



- ⚡ The Device made of Stainless Steel, ABS body, rubber construction.
- ⚡ Corrosion resistant lockout for equipments fitted with the IEC 60320 type input power connector. It fits on most computers, test instruments, power supplies, monitors, lab equipment etc., that use a removable power cord.
- ⚡ This palm-sized, lightweight, simple device accommodates a personal padlock for lockout / security applications.
- ⚡ It prevents the insertion of power cords into machinery that utilize IEC 60320 input power connectors.

**TL - CPCL**  
TajLoto - Computer Power Cord Lockout





# DIGITAL PANEL BLOCKING BAR LOCKOUT

Blocking Bar Lockouts for the computerized digital panels machines lockout.

It helps in restricting the access to the touch buttons on the screen of the electrical panels so that they can not be operated under any circumstances.

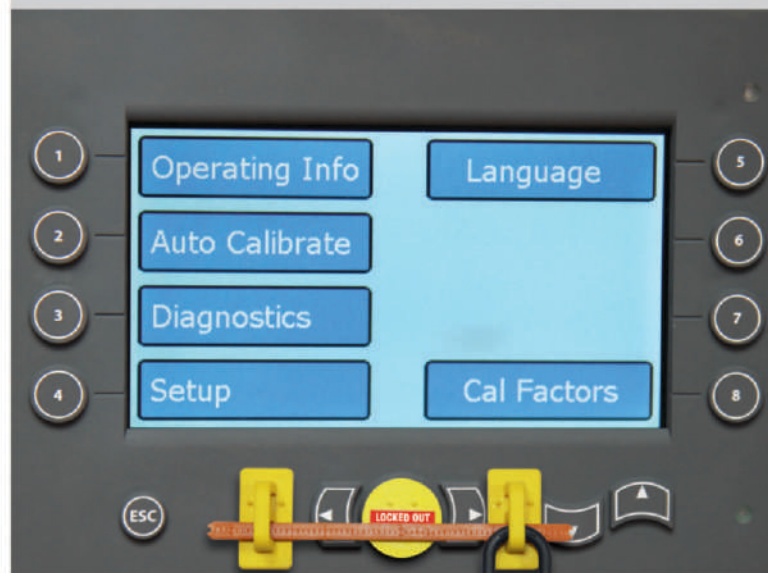
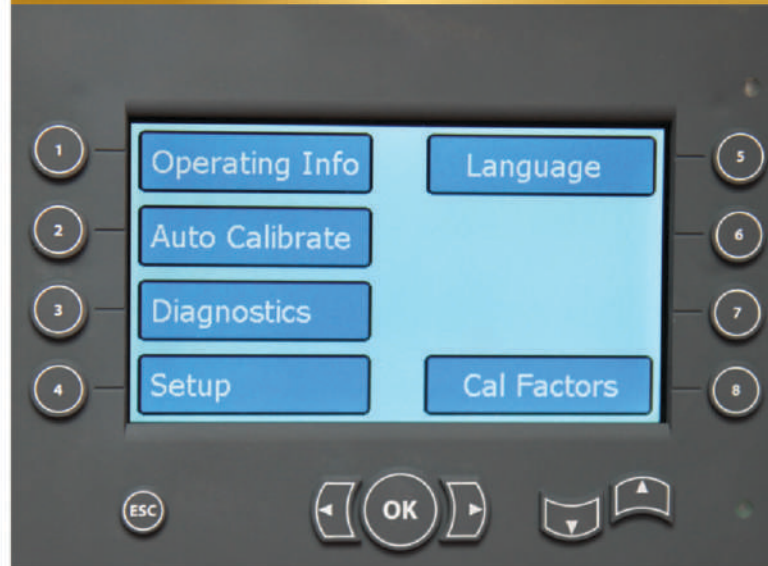

DOMESTIC | [tajlotoindia@gmail.com](mailto:tajlotoindia@gmail.com)  
EXPORT | [tajlotoexport@gmail.com](mailto:tajlotoexport@gmail.com)

[tajlotosafety@gmail.com](mailto:tajlotosafety@gmail.com)  
[www.tajlotosafety.in](http://www.tajlotosafety.in)

# DIGITAL PANEL BLOCKING BAR LOCKOUT



**TAJLOTO SAFETY PVT. LTD.**  
LOCKOUT TAGOUT MANUFACTURER

## DIGITAL PANEL BLOCKING BAR LOCKOUT

- Lockout your oversized & irregularly shaped switches with our BBL : Blocking Bar Lockout.
- Self-adhesive base are permanently installed on electrical panels / switches directly.
- Simply clean panel surface and adhere; No drilling required.
- Red blocking bar indicates locked off, green bar indicates locked on.

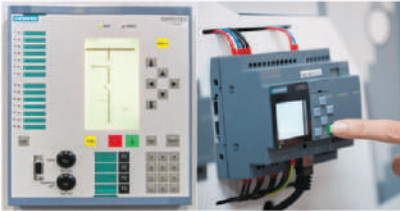

**TL - 1B FB**  
Taj Loto - 1B Flat Base



**TL - 1B THB**  
Taj Loto - 1B Thick Base



**TL - 3.5B THB**  
Taj Loto - 3.5B Thick Base



**TL - BKH**  
Taj Loto - Blocker Hanger



**TL - 4 BG**  
Taj Loto - 4 inch Bar Green



**TL - 8 BG**  
Taj Loto - 8 inch Bar Green



**TL - 4 BR**  
Taj Loto - 4 inch Bar Red



**TL - 8 BR**  
Taj Loto - 8 inch Bar Red



**TL - CB 38**  
Taj Loto  
Circle Blocker 38 mm dia



**TL - CB 75**  
Taj Loto  
Circle Blocker 75 mm dia



**TL - RB**  
Taj Loto - Rectangular Blocker (3 X 4 inch)

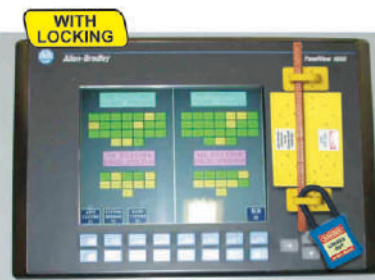

**TL - SB**  
Taj Loto - Square Blocker (2 X 2 inch)

DIGITAL PANEL **BLOCKING BAR**  
**LOCKOUT**

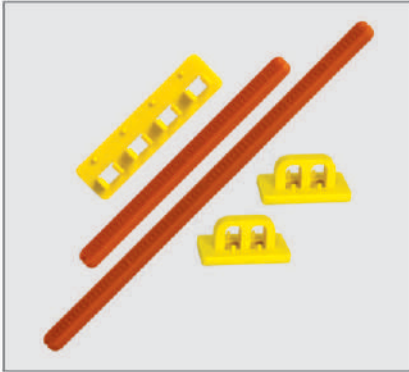

**TL - BBLK-5 FT**  
Taj Loto - Blocking Bar Lockout  
Kit - 5 FLAT

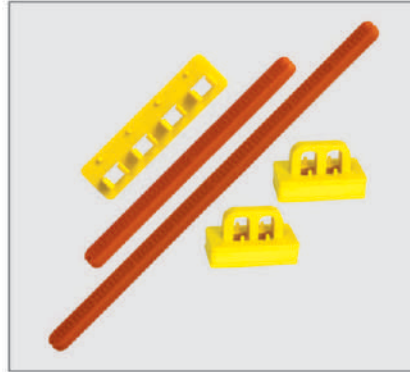

**TL - BBLK-5 TH**  
Taj Loto - Blocking Bar Lockout  
Kit - 5 THICK

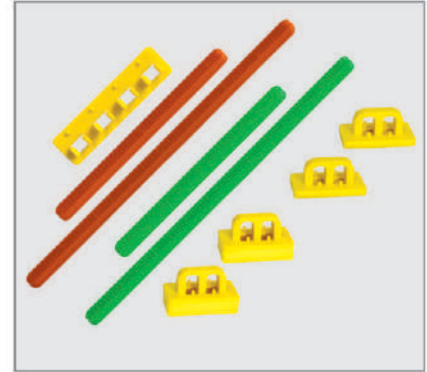

**TL - BBLK-9**  
Taj Loto - Blocking Bar Lockout KIT - 9

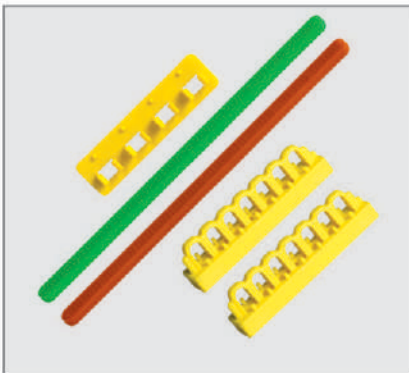

**TL - BBLK-5 3.5 BTH**  
Taj Loto - Blocking Bar Lockout Kit - 5  
3.5 THICK BASE

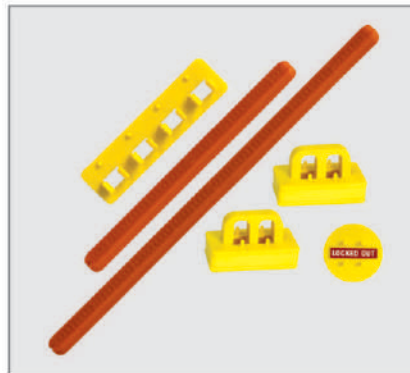

**TL - BBLK-6 C 38**  
Taj Loto - Blocking Bar Lockout Kit - 6  
Circle Blocker 38 mm dia



**TL - BBLK-6 C 75**  
Taj Loto - Blocking Bar Lockout Kit - 6  
Circle Blocker 75 mm dia

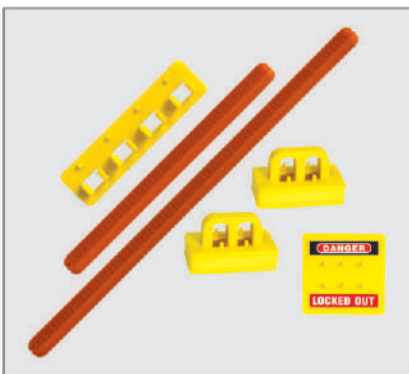

**TL - BBLK-6 SQ**  
Taj Loto - Blocking Bar Lockout Kit - 6  
Square (2 X 2 inch)



**TL - BBLK-6 RT**  
Taj Loto - Blocking Bar Lockout Kit - 6  
Rectangular (3 X 4 inch)



**TL - BBLK-14**  
Taj Loto - Blocking Bar Lockout Kit - 14



## FUSE LOCKOUT

The **Fuse Holder Lockouts** Ideal for preserving the safety of people working on circuits. They are placed into the fuse base by means of a special crew driver.

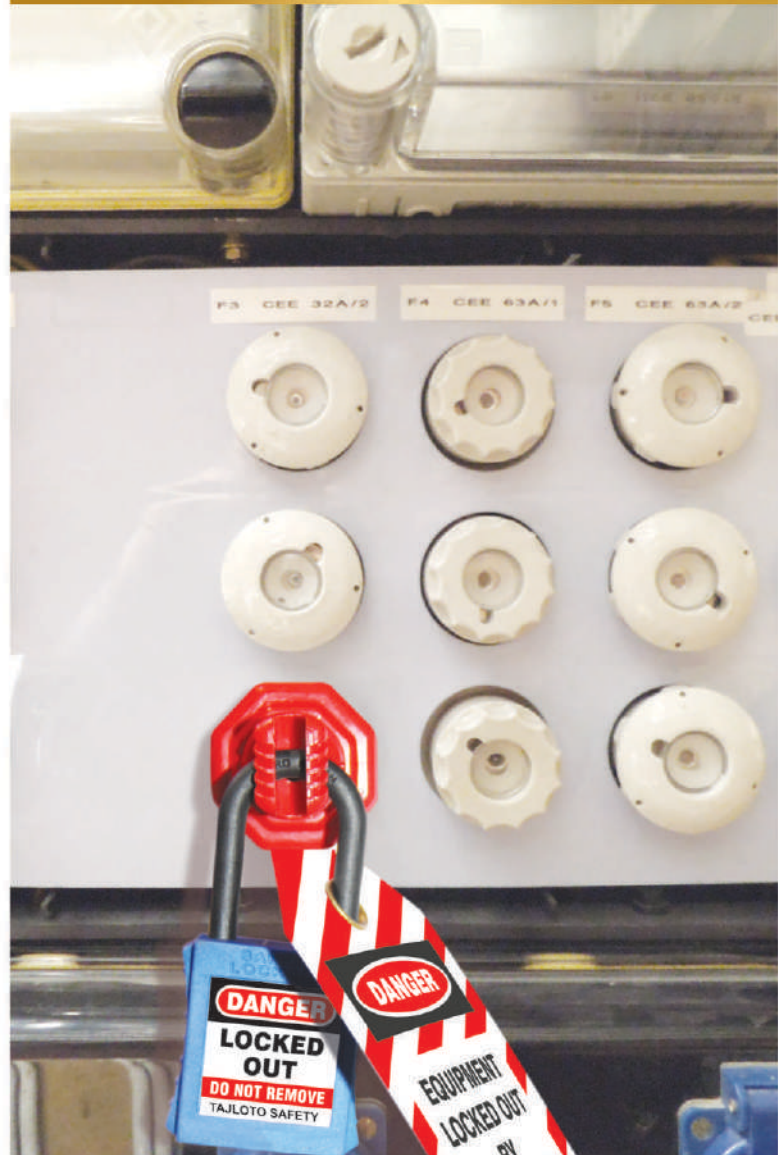

DOMESTIC | [tajlotoindia@gmail.com](mailto:tajlotoindia@gmail.com)  
EXPORT | [tajlotoexport@gmail.com](mailto:tajlotoexport@gmail.com)

[tajlotosafety@gmail.com](mailto:tajlotosafety@gmail.com)  
[www.tajlotosafety.in](http://www.tajlotosafety.in)

## ROUND FUSE HOLDER LOCKOUT

The **Round Fuse Holder Lockouts** Ideal for preserving the safety of people working on circuits. They are placed into the fuse base by means of a special operating tool (Operating tool is not including with products).

This Round Fuse Holder Lockouts are **non-conductive, red color lockouts withstand temperature range: 4°C to +121 °C**. They are being **made of ABS, PC & Steel / Brass components**.

Round Fuse Holder Lockout is available in tow models, each optimized for use with different fuse types:

**TL - Round FHL-1** : DII - suitable for E27 fuses

**TL - Round FHL-2** : DIII - suitable for E33 fuses



Operating Tool for Round FHL



TL - Round FHL-1

TL - Round FHL-2

Taj Loto - Round Fuse Holder Lockout - 1 & 2

## UNIVERSAL FUSE HOLDER LOCKOUT

Designed to be universally compatible with fuse holders. By using a screwdriver this device can be adjusted to fit the holder you're locking out.

Once done, simply insert a padlock through the hole, lock and you'll completely prevent access to the fuse until maintenance is completed.

⚠ This product is suitable for fuse holders from 20A to 400A.

⚠ **Made from Nylon Plastic** with Metal Set screw



**TL - UNIVERSAL FHL-1**  
Taj Loto - Universal Fuse Holder Lockout - 1



**TL - UNIVERSAL FHL-2**  
Taj Loto - Universal Fuse Holder Lockout - 2

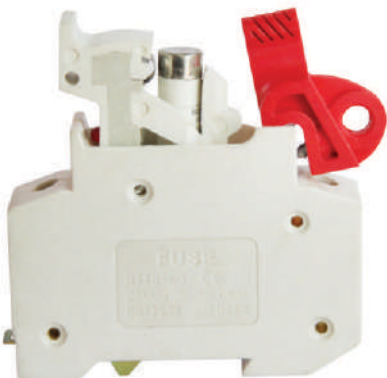

**TL - FHL-3**  
Taj Loto - Fuse Holder Lockout - 3 with Wide Grip Type



**TL - FHL-4**  
Taj Loto - Fuse Holder Lockout - 4 with Thin Grip Type

## FUSE BLOCKER

This both fuse blocker prevents access to areas from which the above fuses have been removed ensuring that they cannot be re-inserted.

- ⚡ Use **4-in-1 way** blocker to fit fuses 1/4", 9/32", 13/32" & 9/16" in size.
- ⚡ Use **2-in-1 way** blocker to fit 13/16", 11/16" & blade type fuses.



**TL - FB 4-in-1**  
Taj Loto - Fuse Blocker  
4 Way in 1 Device



**TL - FB 2-in-1**  
Taj Loto - Fuse Blocker  
2 Way in 1 Device

## FUSE PULLER

- ⚡ Fuse Puller (Medium) for 0-100A / 250 Volt & 600 Volt 1/2" to 1" diameter fuses. 7.5" long, Convenient and handy for replacing or removing cartridge-type fuses.
- ⚡ Easily handle fuses from 0 to 600A range.
- ⚡ De-electric, fully insulated, glass filled polypropylene construction. Safe, non-slip notched handles.
- ⚡ Simple to use, de-electric fuse puller for taking out fuses from the switches before implementing LOTO.



**TL - FP - MS**  
Taj Loto - Fuse Puller  
Medium Size



# ELECTRICAL PANEL LOCKOUT

*We have a Lockout solutions for your HT / LT Electrical Panels.*

*We have some or the other lockout device for your Switches, MCBs, MCCBs, Breakers, Isolators, Push Buttons, Emergency Stops, Levers, Panel Door Knobs / Locks, Handles, Fuses, etc.*

*And if not - We will be happy to make a new lockout device for you.*



DOMESTIC | [tajlotoindia@gmail.com](mailto:tajlotoindia@gmail.com)  
EXPORT | [tajlotoexport@gmail.com](mailto:tajlotoexport@gmail.com)

[tajlotosafety@gmail.com](mailto:tajlotosafety@gmail.com)  
[www.tajlotosafety.in](http://www.tajlotosafety.in)

# ELECTRICAL PANEL LOCKOUT



**TAJLOTO SAFETY PVT. LTD.**  
LOCKOUT TAGOUT MANUFACTURER



## ELECTRICAL PANEL LOCKOUT

- These lockout devices specially designed to lockout electrical panel buttons and switches with no inbuilt lockout provisions.
- Available in various different designs, they all work in a 2-stage operation. The base plate should be attached directly onto the electrical panel over the top of the relevant switch using the super strong adhesive Backing / Riveting / Bolting.
- When in place, the electrical plugs / switches / buttons can be isolated by placing the house unit over the top of base plate - hence preventing the access to the isolated switch. Then, they can be locked in place with a Lockout Padlock.
- The circular units are designed to fit over most of the universal type push panel buttons and the square units are designed for the switches with levers. For the switches with extended handles - we have the special patented lockout solutions that freeze the movement of these switches to a still position where they need to be locked at a specific angle.
- This complete range of products can be cut from any side / direction to suit the installation on different panels.
- Made of Polycarbonate (PC) plastics.

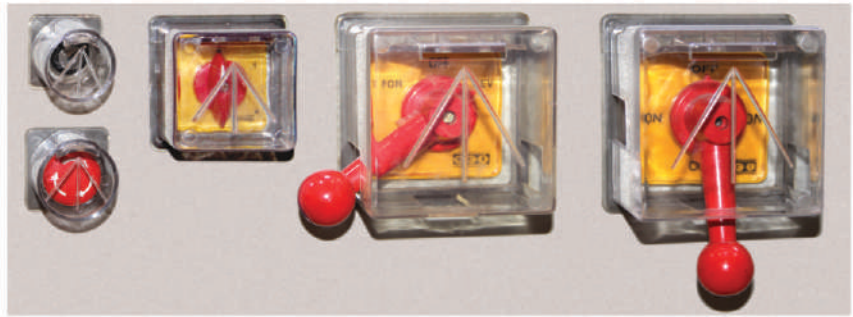

**TL - EPL - R45**  
Taj Loto - Electrical Panel Lockout Round 45



**TL - EPL - R45 Slim**  
Taj Loto - Electrical Panel Lockout Round 45 Slim



**TL - EPL - R55**  
Taj Loto - Electrical Panel Lockout Round 55



**TL - EPL - R55 Slim**  
Taj Loto - Electrical Panel Lockout Round 55 Slim



**TL - EPL - S**  
Taj Loto - Electrical Panel Lockout SMALL



**TL - EPL - M**  
Taj Loto - Electrical Panel Lockout MEDIUM

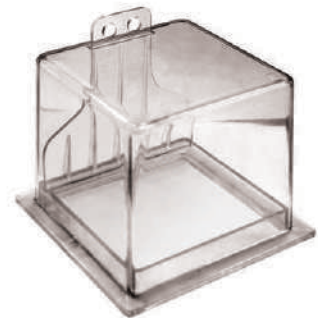

**TL - EPL - L**  
Taj Loto - Electrical Panel Lockout - LARGE



**TL - EPL - M 90 DC**  
Taj Loto - Electrical Panel Lockout MEDIUM 90° Degree Cutout



**TL - EPL - M 45 DC**  
Taj Loto - Electrical Panel Lockout MEDIUM 45° Degree Cutout

**TL - EPL - L 90 DC**  
Taj Loto - Electrical Panel Lockout - LARGE 90° Degree Cutout

**TL - EPL - L 45 DC**  
Taj Loto - Electrical Panel Lockout - LARGE 45° Degree Cutout

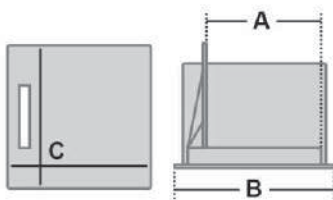

*Customization Accepted*

Dimension	TL- EPL- R45	TL- EPL- R45 Slim	TL - EPL - R55	TL- EPL- R55 Slim	TL- EPL - S	TL- EPL- M TL- EPL- M 90 DC TL- EPL- M 45 DC	TL- EPL - L TL- EPL - L 90 DC TL- EPL - L 45 DC
Model							
Inside Size - L x B (A)	36 mm Dia	36 mm Dia	45 mm Dia	45 mm Dia	46.5 x 50	66 x 74	92 x 100
Base Size - L x B (B)	50 x 50 mm	50 x 50 mm	61 x 61 mm	61 x 61 mm	72 x 72 mm	95 x 95 mm	129 x 129
Cover Size - L x B x H (C)	47 x 45 x 45	47 x 45 x 25 mm	56 x 54 x 46	56 x 54 x 31	62 x 62 x 62	85 x 85 x 62	111 x 111 x 95
No. of Padlock Holes	1	1	1	1	2	2	2

## NORMAL SIZE EMERGENCY PUSH BUTTON LOCKOUT

- ⚡ No one can access the switch after using this device.
- ⚡ Fits both **30.5 mm** and **22.5 mm** diameter switches.
- ⚡ This device is fully transparent allow visibility of nameplate and label.
- ⚡ Retrofit base allows use with raised nameplate and off-center installation to accommodate rotary switch knobs.
- ⚡ Accommodates buttons up to **50 mm** diameter and **45 mm** tall.
- ⚡ One cover, one new install base and one retrofit base with double sided adhesive tape.
- ⚡ Made of Polycarbonate (PC) plastics.



**TL - NPBL**  
Taj Loto - Normal Size  
Emergency Push Button Lockout



**TL - NPBL COMBO**  
Taj Loto - 1 Piece each of TL - BASE NPBL,  
TL - R BASE NPBL and TL - NPBL



**TL - BASE NPBL**  
Taj Loto - Base for  
Normal Size  
Emergency  
Push Button Lockout



**TL - R BASE NPBL**  
Taj Loto - Retrofit Base for  
Normal Size  
Emergency  
Push Button Lockout

## UNIVERSAL EMERGENCY PUSH BUTTON LOCKOUT

- ⚡ Most appreciated lockout solution for the Universal Emergency Push Button Lockout on the electrical panels or on control stations. Also finds its application on the Special crane / heavy machinery.
- ⚡ Made of Polycarbonate (PC) plastics.
- ⚡ The two parts are plugged and then locked out with the help of our lockout padlock.
- ⚡ Inner size of **70 mm x 85 mm** height with **30 mm** dia hole in center.



**TL - U EPBL**  
Taj Loto - Universal  
Emergency  
Push Button Lockout

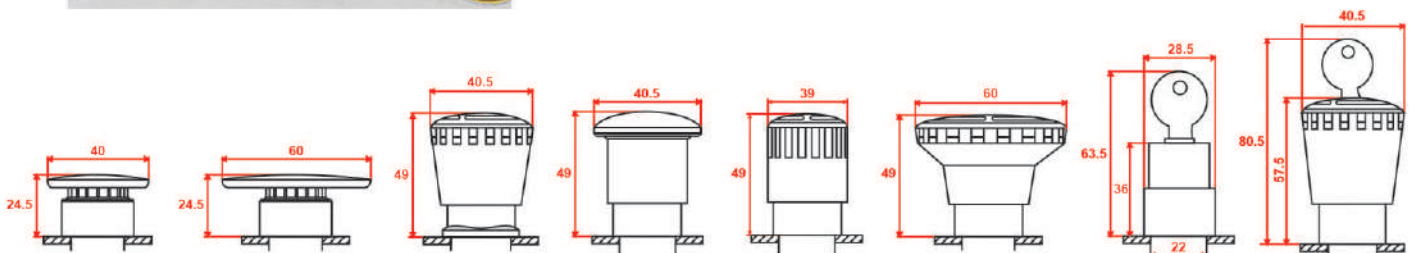

## SWITCH COVER LOCKOUT

- ☛ Made of Polycarbonate (PC) plastics.
- ☛ Prohibits access to a switch or control.
- ☛ Clear bases and cover allow visibility.
- ☛ Accommodates buttons up to 50 mm diameter and 40 mm tall.



**TL - SCL 23**  
Taj Loto  
Switch Cover Lockout  
23mm hole dia.



**TL - SCL 30**  
Taj Loto  
Switch Cover Lockout  
30mm hole dia.



**TL - SCLP 23**  
Taj Loto  
Switch Cover Lockout  
Premier - 23mm hole dia.



**TL - SCLP 30**  
Taj Loto  
Switch Cover Lockout  
Premier - 30mm hole dia.



**TL - SCLP 9**  
Taj Loto  
Switch Cover Lockout  
Premier - 9mm hole dia.

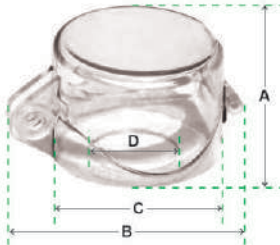

Dimension	TL - SCL 23	TL - SCL 30	TL - SCLP 9	TL - SCLP 23	TL - SCLP 30
Model	TL - SCL 23	TL - SCL 30	TL - SCLP 9	TL - SCLP 23	TL - SCLP 30
Height (A)	32 mm	32 mm	42 mm	42 mm	42 mm
Width (B)	70 mm	70 mm	78 mm	78 mm	78 mm
Base Size (C)	49 mm	49 mm	54 mm	54 mm	54 mm
Hole Dia (D)	23 mm	30 mm	9 mm	23 mm	30 mm

## CUSTOMIZED METALLIC LOCKOUT BOX for Electrical Panel

These customized designed Lockable / Re-openable, Self stick / Rivetable metallic boxes are made from the special solid steel sheets and powder coated to withstand harsh industrial environments. Generally installed on the electrical panels for locking the electrical switches / Buttons, MCBs etc. and are made as per the requirements of the customers / panels in different sizes.



**TL - Cust. MLB**  
Taj Loto - Customized Metallic Lockout Box  
for Electrical Panel (Size : 4.625" X 7.5" X 1")



## PORTABLE EMERGENCY PUSH BUTTON LOCKOUT

Safe & effective method of locking out emergency stop type Mushroom buttons of normal sizes. *Made of Polycarbonate (PC) plastics.* Supplied with a red beak padlock installer. Lockout labels are provided. Inner Dia : **33 x 68 mm**, Hole Dia : **29 mm**



**TL - P EPBL**  
Taj Loto - Portable  
Emergency Push Button Lockout  
for electrical panels



**TL - P EPBL 1**  
Taj Loto - Portable  
Emergency Push Button Lockout - 1  
for electrical panels

## MOTOR STARTER LOCKOUT

- ⚡ Prohibits access to a switch or control.
- ⚡ This lockout can be easily installed by just removing the back strip from the double sided super strong backing.
- ⚡ Padlock can be placed for locking / isolating the switches.
- ⚡ **41 x 70 mm** inner space.
- ⚡ Made of Polycarbonate (PC) plastics.



**TL - MSL**  
Taj Loto - Motor Starter Lockout

## CUSTOMIZED HOLE LOCKOUT FOR ELECTRICAL PANEL

- ⚡ This Customized lockout device **made of Stainless steel sheet** and is installed to the panel surface by using soft washer and aluminium rivet. And a small / large size padlock eye is used depending on the height of the panel door / installation pattern for lockout purpose.
- ⚡ Comes with rubber washer, nut and screw + right angled padlock eye.



**TL - CHL-EP SS**  
Taj Loto - Customized Hole Lockout  
for Electrical Panel - Stainless Steel



**TL - CHL-EP KIT**  
Taj Loto - Customized Hole Lockout  
for Electrical Panel - Kit

## CUSTOMIZED HOLE LOCKOUT FOR ELECTRICAL PANEL

- ⚡ This Lockout Device made of ABS, attached with aluminium rivet. Round Shape De-Electric Lockout device is used to lock the rack-in, rack-out points of air circuit breaker and vacuum circuit breaker, etc. so that no one could operate the particular device. Also used for locking switches that are recessed inside a plane surface.
- ⚡ Easily rotated in any direction - have three holes on the bottom part for fixing it with the help of screws / rivets. It can also be installed to the surface by using the strong double sided tapes.
- ⚡ **Dimension** : Outer Diameter is 46 mm, Inner Diameter is 32 mm, lower cover circle side wall thickness is 7 mm, overall thickness is 8 mm with upper part thickness 3 mm and lower part thickness is 5 mm, locking hole diameter is 10 mm.



**TL - CHL-EP RC**  
Taj Loto - Customized Hole Lockout  
for Electrical Panel - Red colour



**TL - CHL-EP YC**  
Taj Loto - Customized Hole Lockout  
for Electrical Panel - Yellow colour

## HANDLE LOCKOUT - 1 OF ELECTRICAL PANEL

The bigger handles / levers installed on the electrical panels: **made of ABS Red base and flexible black colour powder coated stainless steel strip** of 24.5mm x 300mm with 20 holes makes it impossible for the handles to move from their position once locked with the help of two red clamps and a lockout padlock. Best suitable / Recommended for handles and all kinds of levers having no arrangement for lockout.



**TL - HLEP - 1**  
Taj Loto - Handle Lockout  
of Electrical Panel

**TL - HLEP - 1 DS**  
Taj Loto - Handle Lockout  
of Electrical Panel  
with De-electric Strip  
(Available in white colour)



## HANDLE LOCKOUT - 2 OF ELECTRICAL PANEL

- ⚡ Suitable and effective lockout for L & T & other Breakers. It can be used for ON and OFF positions.
- ⚡ Two holes on the bottom part for fixing it with the help of screws / rivets. It can also be installed to the surface by using the strong double sided tapes.
- ⚡ In order to lockout the switch a padlock should be applied on the handle lockout device.
- ⚡ Has 26 x 31 mm space for lever locking.
- ⚡ Made of Polycarbonate (PC) plastic.



**TL - HLEP-2 - 2 Base**  
Taj Loto - Handle Lockout - 2  
of Electrical Panel with 2 Base



**TL - HLEP - 2**  
Taj Loto - Handle Lockout  
of Electrical Panel



## CUSTOMIZED HOLE LOCKOUT FOR ELECTRICAL PANEL



- ⚡ This Lockout device made especially for the holes in the electrical panels where the Rack-in / Rack-out rods are inserted.
- ⚡ They block the access to the hole and restrict the insertion of the rod for operating the devices inside.
- ⚡ **TL - E - FLH 33** is recommended with this device for installing the locks on it.
- ⚡ Suitable for 20 mm hole dia with 29 mm to 39 mm depth.

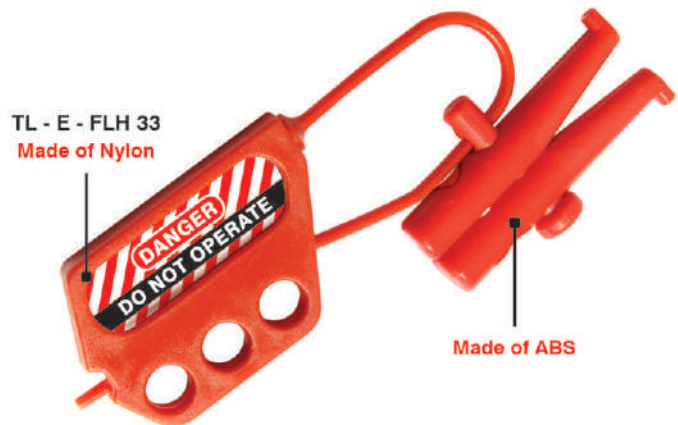

TL - E - FLH 33  
Made of Nylon

Made of ABS

**TL - CHL-EP**  
Taj Loto - Customized Hole Lockout for Electrical Panel with Electric Flexible Lockout Hasp - 33

## SLIDER LOCKOUT

- ⚡ This versatile lockout device prevents the accidental activation of large circuit breakers and can work on a wide variety of flip lever style handle switches. It is **made of red de-electric Polypropylene (PP) plastic**, consists of two parts: Mounting base & Slider bar.
- ⚡ It installs quickly and easily with rivets or screws; installed after drilling hole in the panel body.
- ⚡ Mounting base has a dia of 2" and slide bar measure to 5" long and 1" wide with a provision for providing a lockout padlock.



**TL - SLIDER LOCKOUT**

## SCREW LOCKOUT OF ELECTRICAL PANEL BOXES

Twisting top cap lockout is used for restricting the access to the electrical panel door locks / screw / knob. Made of Polycarbonate (PC) plastics.

**TL - SL - 1** can be installed, where the panel door lock can not be removed.

**TL - SL - 2** can be installed by removing the lock from the panel door and placing the base of SL-2 before inserting the lock in the hole and tightening from the back.

**TL - SL - 3** base is placed at the time of tightening the bakelite screw to the panel door. Twisting top cap is placed for lockout purpose.

**TL - SL - 4** base is placed at the time of tightening the slotted washer head screw to the panel door. Twisting top cap is placed for lockout purpose.



**TL - SL - 1**  
Taj Loto - Screw Lockout - 1  
of Electrical Panel Boxes



**TL - SL - 2**  
Taj Loto - Screw Lockout - 2  
of Electrical Panel Boxes

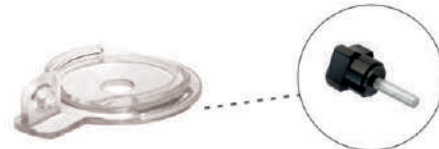

**TL - SL - 3**  
Taj Loto - Screw Lockout - 3  
of Electrical Panel Boxes



**TL - SL - 4**  
Taj Loto - Screw Lockout - 4  
of Electrical Panel Boxes





## GROUP LOCK BOX

*Group lockout boxes help ensure maximum security for complex work team situations. After machine or process is locked out, the key or keys of the machines are placed in a lock box. Each authorised work team member places a personal lock on the group lock box. Ensures that no single employee has access to the box unless all employees have removed their locks.*



DOMESTIC | [tajlotoindia@gmail.com](mailto:tajlotoindia@gmail.com)  
EXPORT | [tajlotoexport@gmail.com](mailto:tajlotoexport@gmail.com)

[tajlotosafety@gmail.com](mailto:tajlotosafety@gmail.com)  
[www.tajlotosafety.in](http://www.tajlotosafety.in)

## GROUP LOCK BOX (GLB)

Simplifies lockout of large equipments and helps ensure maximum security for complex work team situations. After machine or process is locked out, the key or keys of the machines are placed in a lock box. Each authorised work team member places a personal lock on the group lock box. Ensures that no single employee has access to the box unless all employees have removed their locks.

✦ Taj Loto GLB made of special grade metallic sheet. Duly powder coated and supplied with multiple slots in the box body and its flap for holding lockout padlocks. Used for group lockouts.

✦ All GLB available in red colour if you want other colours like yellow, blue, green etc. / your company logo / your department name / **customized label can be supplied as per customer's requirement. \*Minimum Quantity Applicable.**

✦ Size in inches - Height x Width x Depth



Available colours\*



**TL - GLB-R 13 H**  
Taj Loto - Group Lock Box  
Red colour with 13 Hole  
(7" x 10.75" x 4" inch)



**TL - GLB-R 7 H**  
Taj Loto - Group Lock Box  
Red colour with 7 Hole  
(7" x 4.85" x 4" inch)



**TL - GLB-R 17 H**  
Taj Loto - Group Lock Box  
Red colour with 17 Hole  
(7" x 10.75" x 4" inch)



**TL - GLB-R 15 H**  
Taj Loto - Group Lock Box  
Red colour with 15 Hole  
(11.375" x 6" x 3.35" inch)



**TL - GLB-Y 13 H H&C**  
Taj Loto - Group Lock Box  
Yellow colour with 13 Hole  
(HOLE & CLEAR)  
(7" x 4.85" x 4" inch)



Handles available  
in SS & PVC



Minimum Quantity Applicable



**TL - GLB-R WB 13H**  
Taj Loto - Group Lock Box  
Red colour, Wall Bracket with 13 Hole  
(7" x 10.75" x 4" inch)



**TL - GLB-R 13 H C**  
Taj Loto - Group Lock Box  
Yellow colour with 13 Hole  
(CLEAR)  
(7" x 4.85" x 4" inch)

## LARGE SIZE GROUP LOCK BOX

- 🏰 Large size GROUP LOCK BOX are also made to hold important parts of machinery along with keys / fuses etc. They are available with sliding and clear front also.
- 🏰 Taj Loto GLB made of special grade metallic sheet with red colour powder coated.
- 🏰 All GLB available in red colour if you want other colours like yellow, blue, green etc. / your company logo / your department name / **customized label can be supplied as per customer's requirement.** \*Minimum Quantity Applicable.
- 🏰 **Customized GROUP LOCK BOX STORE STATION** are made as per customer's requirement in different sizes.
- 🏰 **Size in inches - Height x Width x Depth**



**TL - GLB-R CT 17H**  
Taj Loto - Group Lock Box - Red  
Clear Top with 17 Hole  
(7" x 13.625" x 7.75" inch)



Minimum Quantity Applicable



**TL - GLB-R TS 26H**  
Taj Loto - Group Lock Box - Red  
Transparent Top Slider with 26 Hole  
(4.25" x 9.25" x 5.5" inch)



**TL - GLB-R LARGE 13 H**  
Taj Loto - Group Lock Box  
Red colour, Large Size with 13 Hole  
(7" x 10" x 7.35" inch)



**TL - GLB-R BIG 4 H**  
Taj Loto - Group Lock Box  
Red colour Big with 4 Hole  
(8.25" x 12.35" x 7.75" inch)

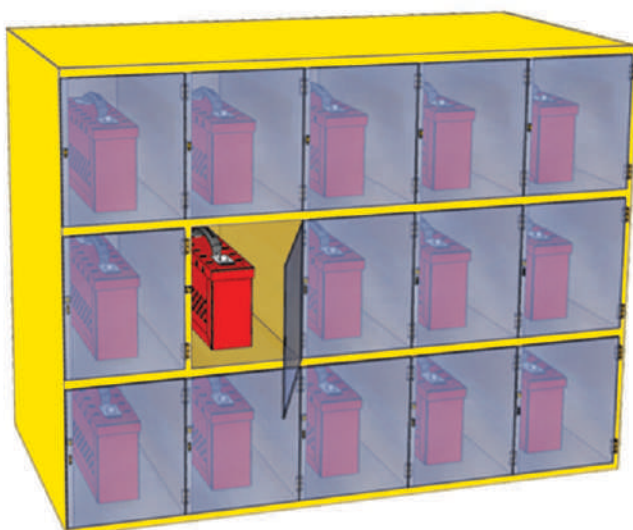

**TL - GLB - SST**  
Taj Loto - Group Lock Box - Store Station  
(This station designed to store TL-GLB-R 13)  
Size : 30" X 60" X 12" inch

**Customization Accepted**  
without any extra charges

## WALL-MOUNT GROUP LOCK BOX (GLB)

- 🔧 Wall mount group lock boxes create a central location for group lockouts throughout your facility.
- 🔧 Durable steel with clear polycarbonate window allows supervisors to double check that the key for each lockout point is enclosed.
- 🔧 Keyhole slot makes it easy to add keys to the box after it has been locked out.
- 🔧 Pre-drilled holes and hardware included.
- 🔧 Provides easy access for employees and is highly visible.
- 🔧 **Size in inches - Height x Width x Depth**



Minimum Quantity Applicable



**TL - GLB-WTS 7 H**  
Taj Loto - Group Lock Box  
Wall-Mount, Transparent Slider with 7 Hole  
(9" x 8" x 2" inch)



**TL - GLB-WTS 9 H**  
Taj Loto - Group Lock Box  
Wall-Mount, Transparent Slider with 9 Hole  
(13" x 12" x 3" inch)



**TL - GLB-WTS 12 H**  
Taj Loto - Group Lock Box  
Wall-Mount, Transparent Slider with 12 Hole  
(9" x 17" x 2" inch)



**TL - D GLB-WTS 12H**  
Taj Loto - DOUBLE Group Lock Box  
Wall-Mount, Transparent Side Slider with 12 Hole  
(7" x 12" x 2" inch)



**TL - GLB-WTS Y**  
Taj Loto - Group Lock Box  
Wall-Mount, Transparent Side Slider - Yellow  
(5" x 14" x 6" inch)

## WALL-MOUNT GROUP LOCK BOX FOR KEYS

- ⚙ These boxes and hooks are made of powder coated special grade steel sheets for maximum durability.
- ⚙ Stainless Steel handle is provided on the top for easy carrying.
- ⚙ Pre-drilled holes and hardware is available for mounting on the wall.
- ⚙ Transparent window for clear visibility of keys and documents.
- ⚙ Comes with durable red and white powder coated finish.
- ⚙ Document holder slots are provided on the main body of this GLB for carrying company's lockout/tagout forms or permits.

⚙ Size in inches - Height x Width x Depth



**TL - WGLB 4 K**

Taj Loto - Wall-Mount  
Group Lock Box with  
arrangement to hang 4 Keys  
(11" x 6" x 3")



**TL - WGLB 8 K**

Taj Loto - Wall-Mount  
Group Lock Box with  
arrangement to hang 8 Keys  
(12" x 12" x 3")



Minimum Quantity Applicable



**TL - WGLB 50 K**

Taj Loto - Wall-Mount  
Group Lock Box with  
arrangement to hang 50 Keys  
(21" x 18" x 3")



Size in inch  
Height x Width x Depth



**TL - WGLB 24 K**

Taj Loto - Wall-Mount  
Group Lock Box with  
arrangement to hang 24 Keys  
(18.75" x 12.5" x 3")

## WALL-MOUNT GROUP LOCK BOX FOR LOCK



- ⚙️ These boxes and hooks are made of powder coated special grade steel sheets for maximum durability.
- ⚙️ Stainless Steel handle is provided on the top for easy carrying.
- ⚙️ Pre-drilled holes and hardware is available for mounting on the wall.
- ⚙️ Transparent window for clear visibility of keys and documents.
- ⚙️ Comes with durable red and white powder coated finish.
- ⚙️ Document holder slots are provided on the main body of this GLB for carrying company's lockout/tagout forms or permits.
- ⚙️ **Size in inches - Height x Width x Depth**



**TL - WGLB 8 L**  
Taj Loto - Wall-Mount  
Group Lock Box with  
arrangement to hang 8 LOCK



**TL - WGLB 4 L**  
Taj Loto - Wall-Mount  
Group Lock Box with  
arrangement to hang 4 LOCK



**Minimum Quantity Applicable**

# GROUP LOCK BOXES



**TAJLOTO SAFETY PVT. LTD.**  
LOCKOUT TAGOUT MANUFACTURER

## WALL-MOUNT GROUP LOCK BOX PLUS STATION

- ✦ Wall-mount group lock boxes + stations provide one central location to store all lockout devices - department wise. Available in small, medium and large sizes to fulfill your lockout needs.
- ✦ Group lockout is very easy to use in any facility, increasing safety as well as communication.
- ✦ Label on inside door serves as a handy reference by providing 10 basic steps for lockout.
- ✦ Ideal for large groups or a facility that needs to lock out many equipments.
- ✦ Clear window lets you see which keys are locked out.
- ✦ Keyhole slot allows keys to be inserted after box has been secured.
- ✦ Size in inches - Height x Width x Depth



**TL - WGLB + PR**  
Taj Loto - Wall-Mount  
Group Lock Box with Padlock Rack  
(19" x 7" x 2")



**TL - WGLB + SS**  
Taj Loto - Wall-Mount  
Group Lock Box with Small Station  
(21" x 10" x 4")



**TL - WGLB + MS**  
Taj Loto - Wall-Mount  
Group Lock Box with Medium Station  
(25" x 15.5" x 4")



**TL - WGLB + LS**  
Taj Loto - Wall-Mount Group Lock Box with Large Station  
(25" x 31" x 4")



Minimum Quantity Applicable

## CUSTOMIZED SAFETY GROUP LOCK BOX

Customized safety group lockout boxes are ideal for group lockout situations, All lockout keys / fuses etc. are placed inside the lockout box and locked by the authorised person.

The TL - SGLB - 5 HL & 8 HL models each worker puts his own padlock and retains its key, ensuring access cannot be gained to the keys / fuses etc. kept inside the box - until the work is completed. Only when all locks are opened the lockout keys and fuses can be accessed.

*Locks can be procured separately as per requirement.*

The TL - SGLB - 3 iL, 4 iL, 5 iL & 8 iL models are supplied with inbuilt locks which can not be removed from their slots.

- ⚠ Control keys can be "same key" for multiple boxes under the control of the responsible person (Control Key).
- ⚠ All secondary keys are "key different".
- ⚠ Keys can be provided with individual identification key chains.
- ⚠ All the boxes have A, B, C,..... or 1,2,3,..... marking for individual locks, which can be customized as per customer's requirement. The keys black portion also have the same numbering / marking as given on the boxes.



**TL - 15BPS SGLB - 5 iL**  
Taj Loto - 15 Box Portable Station of Safety Group Lock Box with 5 Inbuilt Lock on each boxes



**TL - SGLB - 5 HL**  
Taj Loto - Safety Group Lock Box with 5 Hole for Locking (8" x 6" x 4")



**TL - SGLB - 8 HL**  
Taj Loto - Safety Group Lock Box with 8 Hole for Locking (12" x 6" x 4")



**TL - SGLB - 5 iL 12HL**  
Taj Loto - Safety Group Lock Box with 5 Inbuilt Lock & 12 Hole for Locking (9" x 6" x 4")



**TL - 15BS SGLB - 5 iL**  
Taj Loto - 15 Box Station of Safety Group Lock Box with 5 Inbuilt Lock on each boxes (Wall mounted)



**TL - SGLB - 3 iL**  
Taj Loto - Safety Group Lock Box with 3 Inbuilt Lock (5" x 6" x 4")



**TL - SGLB - 4 iL**  
Taj Loto - Safety Group Lock Box with 4 Inbuilt Lock (6.5" x 6" x 4")



**TL - SGLB - 5 iL**  
Taj Loto - Safety Group Lock Box with 5 Inbuilt Lock (8" x 6" x 4")



**TL - SGLB - 8 iL**  
Taj Loto - Safety Group Lock Box with 8 Inbuilt Lock (12" x 6" x 4")

## WALL MOUNT & PORTABLE SMALL GROUP LOCK BOX for KEY & DOCUMENTS

- These box / station are made as per customer requirements in different combinations with written instructions.
- Station can be made and supplied as **wall mounted** or on **revolving wheels** as per the site requirements.
- TL - SGLB - 1, 2, 3, 4 can be selected for required stations.



**TL - SGLB - 1**  
Taj Loto - Small Group Lock Box with 1 Lock Hole (6" x 6" x 2")



**TL - SGLB - 2**  
Taj Loto - Small Group Lock Box with 2 Lock Hole (6" x 8" x 2")



**TL - SGLB - 3**  
Taj Loto - Small Group Lock Box with 3 Lock Hole (6" x 6" x 2")



**TL - SGLB - 4**  
Taj Loto - Small Group Lock Box with 4 Lock Hole (6" x 6" x 2")



**TL - 12 SGLB PST**  
Taj Loto - 12 Small Group Lock Box Portable Station (Single locking provision on each box)



**TL - 6 SGLB ST**  
6 Small Group Lock Box Station

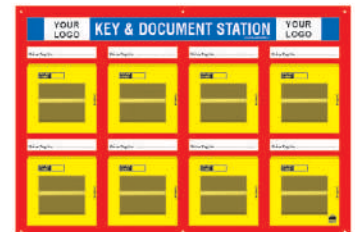

**TL - 8 SGLB ST**  
8 Small Group Lock Box Station

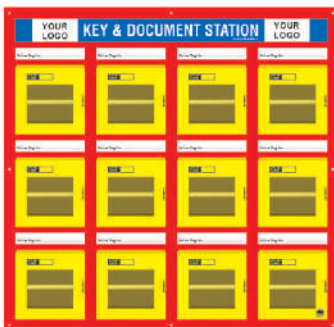

**TL - 12 SGLB ST**  
12 Small Group Lock Box Station



**TL - 16 SGLB ST**  
16 Small Group Lock Box Station

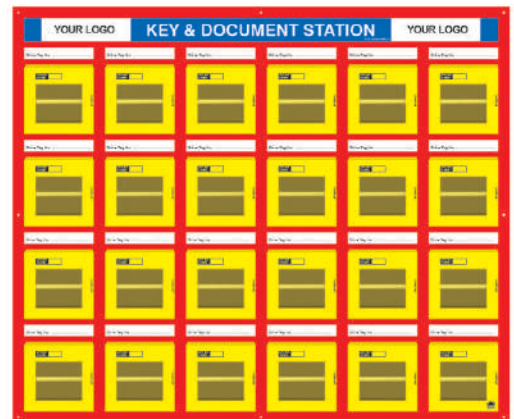

**TL - 24 SGLB ST**  
Taj Loto - 24 Small Group Lock Box Station



# LOCKOUT TAGOUT STATION

*Lockout tagout station ensure that lockout devices are properly stored and always accessible when needed.*

*Industrial strength lockout station offers additional storage space, making it ideal for complex equipment and larger operations.*

*This station is available in portable and wall mounted.*



DOMESTIC | [tajlotoindia@gmail.com](mailto:tajlotoindia@gmail.com)  
EXPORT | [tajlotoexport@gmail.com](mailto:tajlotoexport@gmail.com)

[tajlotosafety@gmail.com](mailto:tajlotosafety@gmail.com)  
[www.tajlotosafety.in](http://www.tajlotosafety.in)

## LOCKOUT TAGOUT STATION

- ☛ Made of powder coated special grade Metallic Sheet. LOTO station supplied with inter changeable shelves & slotted side panels in the box body.
- ☛ Available in with and without clear front lockable shutters. Normally supplied in yellow / red colours.
- ☛ If ordered more than 5 Nos. lockout station, Customization (Printing of Logo / Dept. Name etc.) will be provided free of charge.
- ☛ 4 die cut holes are available for wall mounting.
- ☛ Station Sizes in Inches - **Height x Width x Depth**



**TL - LTS - 1**  
Taj Loto - Lockout Tagout Station - 1  
(Size : 16" x 14" x 6")



**TL - LTS - 1 CF**  
Taj Loto - Lockout Tagout Station - 1 Clear Front  
(Size : 16" x 14" x 6")



**TL - LTS - 2**  
Taj Loto - Lockout Tagout Station - 2  
(Size : 24" x 22" x 10")



**TL - LTS - 2 CF**  
Taj Loto - Lockout Tagout Station - 2 Clear Front  
(Size : 24" x 22" x 10")



**TL - LTS - 3**  
Taj Loto - Lockout Tagout Station - 3  
(Size : 30" x 15" x 9")



**TL - LTS - 3 CF**  
Taj Loto - Lockout Tagout Station - 3 Clear Front  
(Size : 30" x 15" x 9")



**TL - LTS - 1+GLB**  
Taj Loto Lockout Tagout Station - 1 with Group Lock Box  
(Size : 21" x 14" x 6")



**TL - LTS - 1 FS**  
Taj Loto Lockout Tagout Station - 1 with Fixed Shelves  
(Size : 16" x 14" x 6")



**TL - LTS - 4**  
Taj Loto - Lockout Tagout Station - 4  
(Size : 13" x 17.5" x 2.5")



## KEY STATION

- Quality range of keys station offer a simple and affordable solution to your keys storage requirement.
- These station made of special grade Metallic Sheet with powder coated yellow finish. Clear front allows quick visual check of keys without unlocking the stations.
- Supplied with 1 inbuilt security lock and 2 keys.
- 4 wall mounting holes are pre punched at the base plate of the panel for an easy installation.
- Station Sizes in Inches - Height x Width x Depth



**TL - KS - 60**  
Taj Loto - Key Station - 60  
(Key Station for 60 Keys)  
Size : 18" x 15.5" x 2"



**TL - KS - 110**  
Taj Loto - Key Station - 110  
(Key Station for 110 Keys)  
Size : 18" x 15.5" x 2"



**TL - KS - 422**  
Taj Loto - Key Station - 422  
(Key Station for 422 Keys)  
Size : 18.5" x 31" x 4"



**TL - KS - 210**  
Taj Loto - Key Station - 210  
(Key Station for 210 Keys)  
Size : 18" x 15.5" x 4"



**TL - KS - CF 30**  
Taj Loto - Key Station  
Clear Front - 30  
(Key Station for 30 Keys)  
Size : 13" x 10.5" x 2"



**TL - KS - CF 60**  
Taj Loto - Key Station  
Clear Front - 60  
(Key Station for 60 Keys)  
Size : 18" x 15.5" x 2"



**TL - KS - CF 160**  
Taj Loto - Key Station  
Clear Front - 160  
(Key Station for 160 Keys)  
Size : 18" x 15.5" x 4"



**TL - KS - CF 310**  
Taj Loto - Key Station  
Clear Front - 160  
(Key Station for 160 Keys)  
Size : 18.5" x 31" x 4"



**TL - KDS - CF 36**  
Taj Loto - Key & Document Station  
Clear Front - 36  
(Key Station for 30 Keys with Document  
Pocket) Size : 17" x 12.5" x 3"



**TL - KCB TS**  
Taj Loto - Key Control Box  
Wall-Mount, Transparent Side  
Slider with 12 keys hanging  
arrangement (5" x 14" x 6" inch)

## PADLOCK STATION

- Quality range of padlock station offer a simple and affordable solution to your padlock storage requirement.
- These station made of special grade Metallic Sheet with powder coated red colour. Clear front allows quick visual check of padlocks without unlocking the stations.
- Supplied with 1 inbuilt security lock and 2 keys.
- 4 wall mounting holes are pre punched at the base plate of the panel for an easy installation.

Station Sizes in Inches - **Height x Width x Depth**

*Customization Accepted*

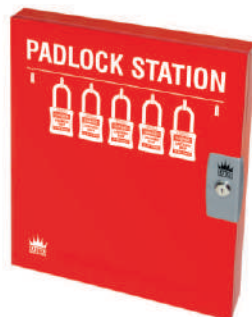

**TL - PS - 21**  
Taj Loto - Padlock Station - 21  
(Padlock Station for 21 Padlocks)  
Size : 18" x 15.5" x 2"

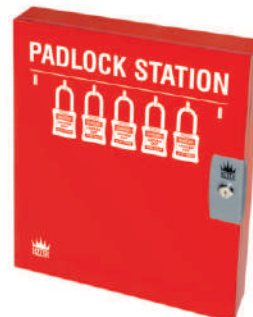

**TL - PS - 42**  
Taj Loto - Padlock Station - 42  
(Padlock Station for 42 Padlocks)  
Size : 18" x 15.5" x 3"

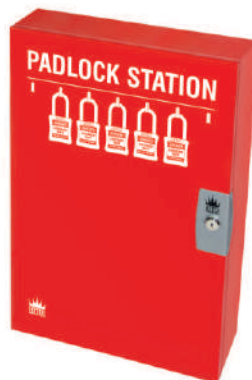

**TL - PS - 112**  
Taj Loto - Padlock Station - 112  
(Padlock Station for 112 Padlocks)  
Size : 23" x 15.5" x 5.5"



**TL - PS - 220**  
Taj Loto - Padlock Station - 220  
(Padlock Station for 220 Padlocks)  
Size : 23" x 31.5" x 5.5"



**TL - PS - CF 21**  
Taj Loto - Padlock Station  
Clear Front - 21  
(Padlock Station for 21 Padlocks)  
Size : 18" x 15.5" x 2"



**TL - PS - CF 28**  
Taj Loto - Padlock Station  
Clear Front - 28  
(Padlock Station for 28 Padlocks)  
Size : 23" x 15.5" x 2"



**TL - PS - CF 84**  
Taj Loto - Padlock Station  
Clear Front - 84  
(Padlock Station for 84 Padlocks)  
Size : 23" x 15.5" x 5.5"



**TL - PS - CF 10**  
Taj Loto - Padlock Station  
Clear Front - 10  
(Padlock Station for 10 Padlocks)  
Size : 13" x 10.5" x 2"



**TL - PS - CF 168**  
Taj Loto - Padlock Station  
Clear Front - 164  
(Padlock Station for 164 Padlocks)  
Size : 23" x 31.5" x 5.5"

## TAG & HASP STATION

- ☛ Designed to store Lockout Tags & Hasps.
- ☛ This station made of special grade Metallic Sheet with powder coated red colour. Clear front allows quick visual.
- ☛ You can be stored in this station 50 number Tags and 50 number Hasps.
- ☛ Supplied with 1 inbuilt security lock and 2 keys.
- ☛ 4 wall mounting holes are pre punched at the base plate of the panel for an easy installation.
- ☛ Station Sizes in Inches - **36" Height x 22" Width x 2" Depth.**

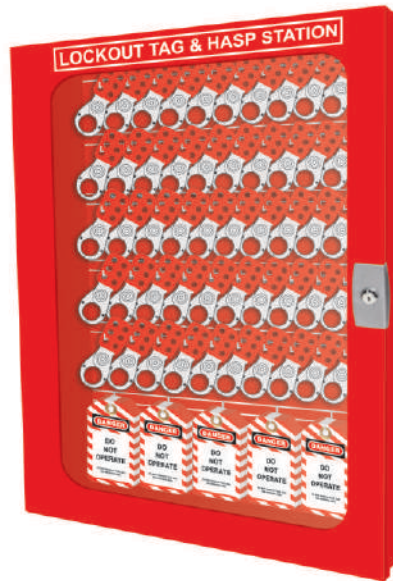

### TL - T&H STATION

Taj Loto - Tag and Hasp Station with 55 Hooks for hanging.

### TL - T&H STATION WG

Taj Loto - Tag and Hasp Station with goods (50 Tags + 50 Small Hasp).



## CUSTOMIZED KEY BOX MINI STATION

- Wall-mount customized group lock box.
- This customized group lock box capture the keys from those lockout points by placing them in the lock box.
- Each authorized employee locks one personal safety lock onto the box, removing them only when their work is complete. The keys cannot be accessed until the last lock is removed.
- Made of durable metal sheet with red colour powder-coated finish.
- Accommodates up to 8 workers, more with the use of lockout hasps.
- Sizes in Inches - 8" Height x 6.5" Width x 1.75" Depth.



**TL - C-GLB 3K**  
Taj Loto - Customized  
Group Lock Box  
with arrangement to hang 3 Keys

- Wall mounted Emergency key box Mini Station with clear front.
- Single key hanging arrangement with hammer.
- Supplied with 1 inbuilt security lock and 2 keys.
- Made of red powder coated metal sheets.
- Station Sizes in Inches - 5" Height x 5" Width x 1.75" Depth



**TL - C-EKB**  
Taj Loto - Customized  
Emergency Key Box  
(Single Key hanging provision with hammer)  
Size : 6" x 5" x 1.75"

- Wall mounted Emergency key box Mini Station with clear front.
- Single key hanging arrangement with hammer.
- Made of red powder coated metal sheets.
- Station Sizes in Inches - 6" Height x 5" Width x 1.75" Depth



**TL - C-EKB - 1**  
Taj Loto - Customized  
Emergency Key Box  
(Single Key hanging provision  
with hammer)



**TL - C-EKB R1**  
Taj Loto - Customized  
Emergency Key Box Round  
(Single Key hanging provision with hammer)  
Size : 5" x 5" x 1.75"



## HOOK TYPE LOCKOUT STATION



**TL - HTLS - 5P WG / WOG**

Taj Loto - Hook Type Lockout Station  
for 5 Padlocks (with / without goods)  
(Size : 15" x 12.5")

- |                 |           |
|-----------------|-----------|
| 1. PLSP 46 - KD | : 5 nos.  |
| 2. PCH - S      | : 1 no.   |
| 3. PCH - P      | : 1 no.   |
| 4. TLT-1 Tag    | : 10 nos. |



**TL - HTLS - 10P WG / WOG**

Taj Loto - Hook Type Lockout Station  
for 10 Padlocks (with / without goods)  
(Size : 16" x 20")

- |                 |           |
|-----------------|-----------|
| 1. PLSP 46 - KD | : 10 nos. |
| 2. PCH - S      | : 2 nos.  |
| 3. PCH - P      | : 2 nos.  |
| 4. TLT-1 Tag    | : 20 nos. |



**TL - HTLS - 20P WG / WOG**

Taj Loto - Hook Type Lockout Station  
for 20 Padlocks (with / without goods)  
(Size : 21" x 20")

- |                 |           |
|-----------------|-----------|
| 1. PLSP 46 - KD | : 20 nos. |
| 2. PCH - S      | : 1 no.   |
| 3. PCH - P      | : 1 no.   |
| 4. TLT-1 Tag    | : 30 nos. |



**TL - HTLS - 36P WG / WOG**

Taj Loto - Hook Type Lockout Station  
for 36 Padlocks (with / without goods)  
(Size : 27" x 24")

- |                 |           |
|-----------------|-----------|
| 1. PLSP 46 - KD | : 36 nos. |
| 2. PCH - S      | : 1 no.   |
| 3. PCH - P      | : 1 no.   |
| 4. TLT-1 Tag    | : 40 nos. |

- Hook type Lockout Station are designed as per internationally accepted configurations to hold Lockout padlocks / tags / hasps near to the isolating points.
- These Lockout Station are made of ACP (Aluminium Composite Panel) by using the Transparent hooks.
- These station can be made and supplied as per the customer's requirements.
- They can be supplied in any language with the company logo.

Details of product code:-

- TL - PLSP 46 - KD** : Premier Lockout Safety Padlock with 46mm Steel Shackle Height - Key Different
- TL - PCH - S** : PVC Coated Hasp - Small
- TL - PCH - P** : PVC Coated Hasp - Premier
- TLT - 1** : Taj Loto Tags - 1



**TL - HTHS - 30H WG / WOG**

Taj Loto - Hook Type Hasp Station  
for 30 Hasp, TL-PCH-S (with / without goods)  
(Size : 21" x 20")



*Before ordering, please confirm  
Stations are required  
with or without goods*

## RAIL TYPE LOCKOUT STATION

⚠ **Rail type Lockout Stations** are designed to hold Lockout padlocks / tags / hasps near to the isolating points.

⚠ These Lockout Station are **made of ACP (Aluminium Composite Panel)** by using the Transparent hooks.

⚠ **Details of product code:-**

- TL - PLSP 46 - KD : Premier Lockout Safety Padlock with 46mm Steel Shackle Height - Key Different
- TL - PCH - S : PVC Coated Hasp - Small
- TL - PCH - P : PVC Coated Hasp - Premier
- TLT - 1 : Taj Loto Tags - 1

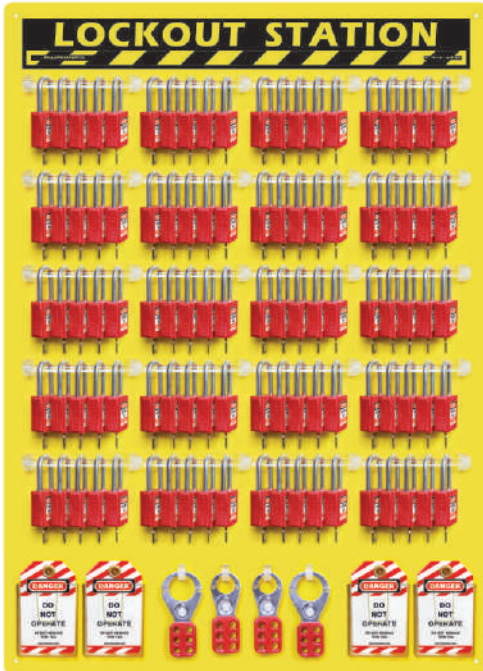

### TL - RTLS - 100P WG / WOG

Taj Loto - Rail Type Lockout Station for 100 Padlocks (with / without goods) Size : 39.5" x 28.5"

1. PLSP 46 - KD : 100 nos.
2. PCH - S : 2 nos.
3. PCH - P : 2 nos.
4. TLT-1 Tag : 40 nos.



### TL - RTLS - 5P WG / WOG

Taj Loto - Rail Type Lockout Station for 5 Padlocks (with / without goods) (Size : 11.5" x 11.5")

1. PLSP 46 - KD : 5 nos.
2. PCH - S : 1 no.
3. PCH - P : 1 no.
4. TLT-1 Tag : 10 nos.



### TL - RTLS - 10P WG / WOG

Taj Loto - Rail Type Lockout Station for 10 Padlocks (with / without goods) (Size : 14" x 14")

1. PLSP 46 - KD : 10 nos.
2. PCH - S : 1 no.
3. PCH - P : 1 no.
4. TLT-1 Tag : 20 nos.



*Before ordering, please confirm Stations are required with or without goods*

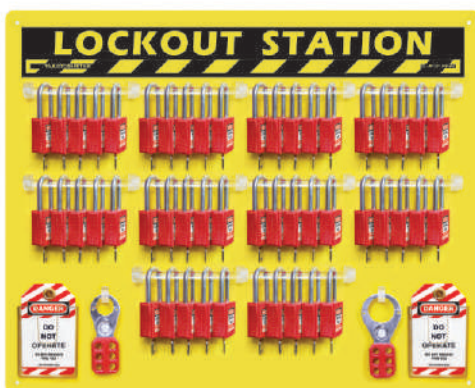

### TL - RTLS - 50P WG / WOG

Taj Loto - Rail Type Lockout Station for 50 Padlocks (with / without goods) Size : 23" x 28.5"

1. PLSP 46 - KD : 50 nos.
2. PCH - S : 1 no.
3. PCH - P : 1 no.
4. TLT-1 Tag : 20 nos.



### TL - RTLS - 36P WG / WOG

Taj Loto - Rail Type Lockout Station for 36 Padlocks (with / without goods) Size : 23" x 22"

1. PLSP 46 - KD : 36 nos.
2. PCH - S : 1 no.
3. PCH - P : 1 no.
4. TLT-1 Tag : 40 nos.



### TL - RTLS - 20P WG / WOG

Taj Loto - Rail Type Lockout Station for 20 Padlocks (with / without goods) (Size : 20.5" x 12.5")

1. PLSP 46 - KD : 20 nos.
2. PCH - P : 1 no.
3. TLT-1 Tag : 20 nos.

## SHADOW LOCKOUT STATION

- These shadow lockout stations are design to keep isolation devices close to the machine that is to be locked out.
- Highly visible design and devices shadows are a status indicators, clearly showing which piece of equipment is in use.
- Made from 4 mm ACP (Aluminium Composite Panel).**
- These station can be made and supplied as per the customer's requirements.

### Details of product code:-

- TL - PLSP 46 - KD : Premier Lockout Safety Padlock with 46mm Steel Shackle Height - Key Different
- TL - PCH - S : PVC Coated Hasp - Small
- TL - PCH - P : PVC Coated Hasp - Premier
- TLT - 1 : Taj Loto Tags - 1



Before ordering, please confirm  
Stations are required  
with or without goods



**TL - SLS - 5P WOG**  
Taj Loto - Shadow Lockout Station  
for 5 Padlocks without goods  
(Size : 16" x 11.75")

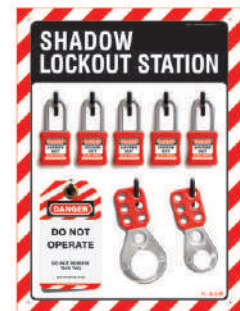

**TL - SLS - 5P WG**  
Taj Loto - Shadow Lockout Station  
for 5 Padlocks with goods  
(Size : 16" x 11.75")

- 
- |                 |           |
|-----------------|-----------|
| 1. PLSP 46 - KD | : 5 nos.  |
| 2. PCH - S      | : 1 no.   |
| 3. PCH - P      | : 1 no.   |
| 4. TLT-1 Tag    | : 10 nos. |
- 

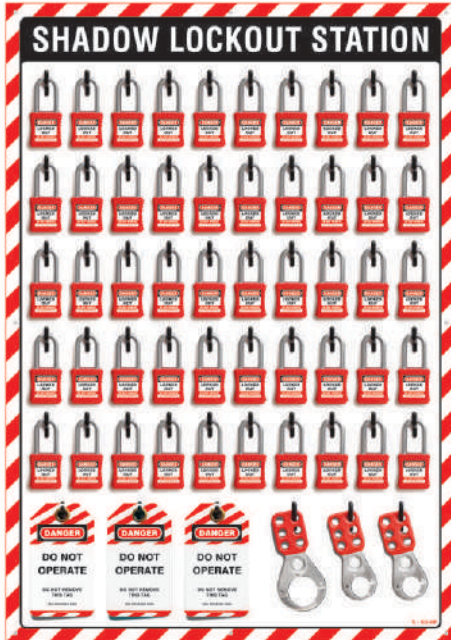

**TL - SLS - 50P WG / WOG**  
Taj Loto - Shadow Lockout Station  
for 50 Padlocks (with / without goods)  
(Size : 32" x 22.5")

- 
- |                 |           |
|-----------------|-----------|
| 1. PLSP 46 - KD | : 50 nos. |
| 2. PCH - S      | : 2 nos.  |
| 3. PCH - P      | : 1 no.   |
| 4. TLT-1 Tag    | : 30 nos. |
- 



**TL - SLS - 21P WG / WOG**  
Taj Loto - Shadow Lockout Station  
for 21 Padlocks (with / without goods)  
(Size : 23.5" x 16")

- 
- |                 |           |
|-----------------|-----------|
| 1. PLSP 46 - KD | : 21 nos. |
| 2. PCH - S      | : 1 no.   |
| 3. PCH - P      | : 1 no.   |
| 4. TLT-1 Tag    | : 20 nos. |
- 



**TL - SLS - 10P WG / WOG**  
Taj Loto - Shadow Lockout Station  
for 10 Padlocks (with / without goods)  
(Size : 20.5" x 12")

- 
- |                 |           |
|-----------------|-----------|
| 1. PLSP 46 - KD | : 10 nos. |
| 2. PCH - S      | : 1 no.   |
| 3. PCH - P      | : 1 no.   |
| 4. TLT-1 Tag    | : 20 nos. |
-

## SHADOW LOCKOUT STATION



**TL - SLTS - 120T WG / WOG**  
Taj Loto - Shadow Lockout Tag Station  
for 120 Tags (with / without goods)  
(Size : 23.5" x 18")

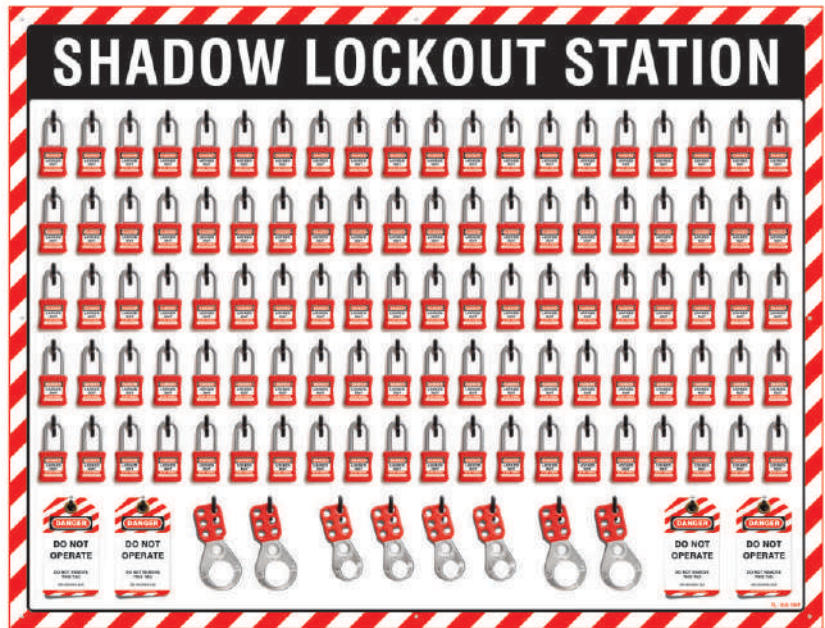

**TL - SLS - 100P WG / WOG**  
Taj Loto - Shadow Lockout Station  
for 100 Padlocks (with / without goods)  
(Size : 36" x 47")

- |                 |            |
|-----------------|------------|
| 1. PLSP 46 - KD | : 100 nos. |
| 2. PCH - S      | : 4 nos.   |
| 3. PCH - P      | : 4 nos.   |
| 4. TLT-1 Tag    | : 40 nos.  |

Customized with your  
Company logo

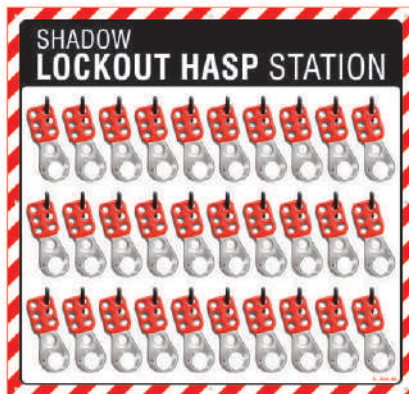

**TL - SLHS - 30H WG / WOG**  
Taj Loto - Shadow Lockout Hasp Station  
for 30 Hasp (with / without goods)  
(Size : 22.5" x 23.5")

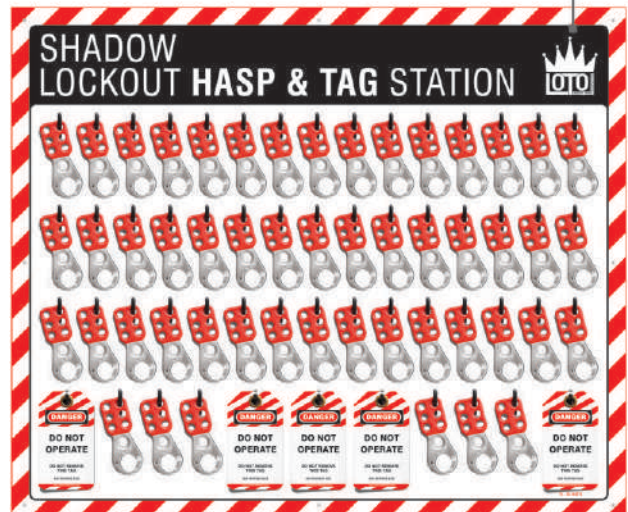

**TL - SL H&T S WG / WOG**  
Taj Loto - Shadow Lockout  
HASP & TAG Station  
with / without goods (Size : 29.5 x 35.5")

- |              |           |
|--------------|-----------|
| 1. PCH - S   | : 51 nos. |
| 3. TLT-1 Tag | : 50 nos. |



Before ordering, please confirm  
Stations are required **with or without goods**

## YELLOW & BLACK SHADOW LOCKOUT STATION

These shadow lockout stations are design to keep isolation devices close to the machine that is to be locked out.

**Made from 4 mm ACP (Aluminium Composite Panel).**

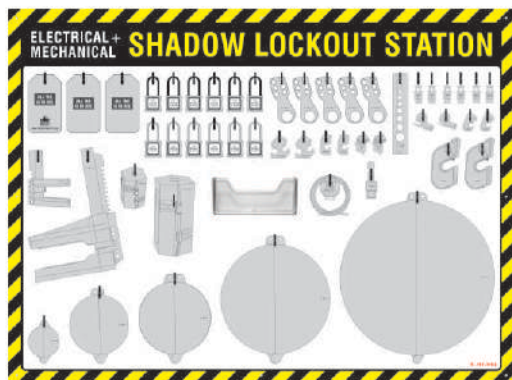

**TL - YB E+M SLS WG / WOG**

Taj Loto - Yellow & Black ELECTRICAL + MECHANICAL  
Shadow Lockout Station (with / without goods)  
Size : 35.5" X 48"

- WITH GOODS : Details**
- PVC Coated Hasp - Small \_\_\_\_\_ - 5 nos.
  - Premier Lockout Safety Padlock - Key Different \_\_\_\_\_ - 6 nos.
  - De-Electric - Premier Lockout Safety Padlock - Key Different \_\_\_\_\_ - 6 nos.
  - PIN-IN, PIN-OUT, PIN-OUT-WIDE & TIE BAR (2 Piece each) \_\_\_\_\_ - 8 nos.
  - Universal Fuse Holder Lockout (Thin & Wide) \_\_\_\_\_ - 2 nos.
  - Mini Circuit Breaker Lockout - Yellow \_\_\_\_\_ - 2 nos.
  - Universal Mini Circuit Breaker Lockout - Blue \_\_\_\_\_ - 2 nos.
  - Universal Big size Circuit Breaker Lockout \_\_\_\_\_ - 2 nos.
  - Universal 2-IN-1 Circuit Breaker Lockout \_\_\_\_\_ - 2 nos.
  - Computer Power Cord Lockout \_\_\_\_\_ - 1 no.
  - Economy Cable Lockout with 2 Mtrs. Vinyl Coated Steel \_\_\_\_\_ - 1 set  
Cable without loop
  - Small Plug Lockout - Premier \_\_\_\_\_ - 1 no.
  - Large Plug Lockout - Premier \_\_\_\_\_ - 1 no.
  - Pneumatic Lockout Straight with 9 Holes \_\_\_\_\_ - 2 nos.
  - Gate Valve Lockout (GVL - 2) \_\_\_\_\_ - 1 no.
  - Gate Valve Lockout (GVL - 4) \_\_\_\_\_ - 1 no.
  - Gate Valve Lockout (GVL - 6) \_\_\_\_\_ - 1 no.
  - Gate Valve Lockout (GVL - 8) \_\_\_\_\_ - 1 no.
  - Gate Valve Lockout (GVL - 10) \_\_\_\_\_ - 1 no.
  - Ball Valve Lockout - 2 (in Top Locking Provision) \_\_\_\_\_ - 1 no.
  - Ball Valve Lockout - 3 Large (in Top Locking Provision) \_\_\_\_\_ - 1 no.
  - Taj Loto Tags \_\_\_\_\_ - 30 nos.



**TL - YB VL SLS WG / WOG**

Taj Loto - Yellow & Black VALVE Shadow  
Lockout Station (with / without goods)  
Size : 35.5" x 33"

- Gate Valve Lockout (GVL - 2) \_\_\_\_\_ - 1 no.
- Gate Valve Lockout (GVL - 4) \_\_\_\_\_ - 1 no.
- Gate Valve Lockout (GVL - 6) \_\_\_\_\_ - 1 no.
- Gate Valve Lockout (GVL - 8) \_\_\_\_\_ - 1 no.
- Gate Valve Lockout (GVL - 10) \_\_\_\_\_ - 1 no.
- Premier Lockout Safety Padlock - Key Different \_\_\_\_\_ - 6 nos.
- Electric - Flexible Lockout Hasp - 6 holes \_\_\_\_\_ - 2 nos.
- Ball Valve Lockout - 2 (in Top Locking Provision) \_\_\_\_\_ - 1 no.
- Ball Valve Lockout - 3 Large (in Top Locking Provision) \_\_\_\_\_ - 1 no.
- Standard - Small - Ball Valve Lockout \_\_\_\_\_ - 1 no.
- Standard - Large - Ball Valve Lockout \_\_\_\_\_ - 1 no.
- Taj Loto Tags \_\_\_\_\_ - 10 nos.



**TL - YB CB SLS WG / WOG**

Taj Loto - Yellow & Black CIRCUIT  
BREAKER Shadow Lockout Station  
(with / without goods) Size : 23" x 17"

- Electric - Flexible Lockout Hasp - 6 holes \_\_\_\_\_ - 2 nos.
- De-Electric - Premier Lockout Safety Padlock - Key Different \_\_\_\_\_ - 5 nos.
- PIN-IN, PIN-OUT, PIN-OUT-WIDE & TIE BAR (2 Piece each) \_\_\_\_\_ - 8 nos.
- Mini Circuit Breaker Lockout - Yellow \_\_\_\_\_ - 2 nos.
- Universal Mini Circuit Breaker Lockout - Blue \_\_\_\_\_ - 2 nos.
- Universal Big size Circuit Breaker Lockout \_\_\_\_\_ - 2 nos.
- Universal 2-IN-1 Circuit Breaker Lockout \_\_\_\_\_ - 2 nos.
- Universal Golden Toggle - Mini Circuit Breaker Lockout \_\_\_\_\_ - 6 nos.
- Taj Loto Tags \_\_\_\_\_ - 10 nos.



*Before ordering, please confirm  
Stations are required with or without goods*

# SHADOW LOCKOUT STATION



**TAJLOTO SAFETY PVT. LTD.**  
LOCKOUT TAGOUT MANUFACTURER

## ELECTRICAL SHADOW LOCKOUT STATION



**TL - ELECT. SLS WG / WOG**  
Taj Loto - ELECTRICAL  
Shadow Lockout Station  
(with / without goods)  
Size : 45.5" X 45.5"

### WITH GOODS : Details

1. PVC Coated Hasp - Small \_\_\_\_\_ - 2 nos.
2. De - Electric Slider Hasp for 4 Locks / 3 mm shackle \_\_\_\_\_ - 2 nos.
3. De - Electric Slider Hasp for 4 Locks / 6 mm shackle \_\_\_\_\_ - 2 nos.
4. Electric - Flexible Lockout Hasp 3 holes / 3 mm shackle \_\_\_\_\_ - 2 nos.
5. Electric - Flexible Lockout Hasp 3 holes / 6 mm shackle \_\_\_\_\_ - 2 nos.
6. Electric - Flexible Lockout Hasp 6 holes / 6 mm shackle \_\_\_\_\_ - 2 nos.
7. De-Electric Premier Lockout Safety Padlock, Nylon shackle - Key Different \_\_\_\_\_ - 10 nos.
8. PIN-IN, PIN-OUT, PIN-OUT-WIDE & TIE BAR (2 Piece each) \_\_\_\_\_ - 8 nos.
9. Universal Circuit Breaker Lockout, A Tail Type with Twister Screw \_\_\_\_\_ - 2 nos.
10. Universal 2-IN-1 Circuit Breaker Lockout \_\_\_\_\_ - 2 nos.
11. Universal Golden Toggle - Mini Circuit Breaker Lockout \_\_\_\_\_ - 2 nos.
12. Two Side Toggle Hasp \_\_\_\_\_ - 2 nos.
13. Universal Multi Pole Breaker Lockout \_\_\_\_\_ - 2 nos.
14. Tool Free - Combo Circuit Breaker Lockout (2 nos. TL- TF CBL & 2 nos. TL- TF UCBL) \_\_\_\_\_ - 2 set
15. Tight Grip Circuit Breaker Lockout - Small & Large (1 Piece each) \_\_\_\_\_ - 1 set
16. Clamp-on Breaker Lockout - Small for 120 / 277 V breakers \_\_\_\_\_ - 2 nos.
17. Cleat for Small Clamp-on Breaker Lockout \_\_\_\_\_ - 2 nos.
18. Clamp-on Breaker Lockout - Medium for 480 / 600 V breakers \_\_\_\_\_ - 1 no.
19. Cleat for Medium Clamp-on Breaker Lockout \_\_\_\_\_ - 1 no.
20. Clamp-on Breaker Lockout - Large (fits on breaker switches up to 21 / 4" wide and 7 / 8" thick) \_\_\_\_\_ - 1 no.
21. Large Circuit Breaker Lockout with Round Handle \_\_\_\_\_ - 2 nos.
22. Portable Emergency Push Button Lockout \_\_\_\_\_ - 2 nos.
23. Universal Emergency Push Button Lockout \_\_\_\_\_ - 2 nos.
24. Universal Big size Circuit Breaker Lockout \_\_\_\_\_ - 2 nos.
25. Mini Circuit Breaker Lockout - Yellow \_\_\_\_\_ - 2 nos.
26. Pin & Sleeve Plug Lockout \_\_\_\_\_ - 3 nos.
27. Small Plug Lockout - Premier \_\_\_\_\_ - 1 no.
28. Large Plug Lockout - Premier \_\_\_\_\_ - 1 no.
29. Computer Power Cord Lockout \_\_\_\_\_ - 1 no.
30. Universal Fuse Holder Lockout - 1 \_\_\_\_\_ - 2 nos.
31. Universal Fuse Holder Lockout - 2 \_\_\_\_\_ - 2 nos.
32. Fuse Holder Lockout - 3 with Wide Grip Type \_\_\_\_\_ - 2 nos.
33. Fuse Holder Lockout - 4 with Thin Grip Type \_\_\_\_\_ - 2 nos.
34. Fuse Puller Medium Size \_\_\_\_\_ - 1 no.
35. Economy Cable Lockout with 2 Mtrs. Vinyl Coated Steel Cable without loop \_\_\_\_\_ - 2 set
36. Squeezer Cable Lockout with De-Electric cable - Yellow \_\_\_\_\_ - 2 nos.
37. Hanging Lockout Sign (6" x 8") \_\_\_\_\_ - 1 no.
38. Taj Loto Tags \_\_\_\_\_ - 30 nos.
39. Nylon Ties for Tags \_\_\_\_\_ - 30 nos.
40. Special Pen with eraser for tags \_\_\_\_\_ - 1 no.
41. Screw Driver \_\_\_\_\_ - 1 no.



*Before ordering,  
please confirm  
Stations are  
required with or  
without goods*

## MECHANICAL SHADOW LOCKOUT STATION

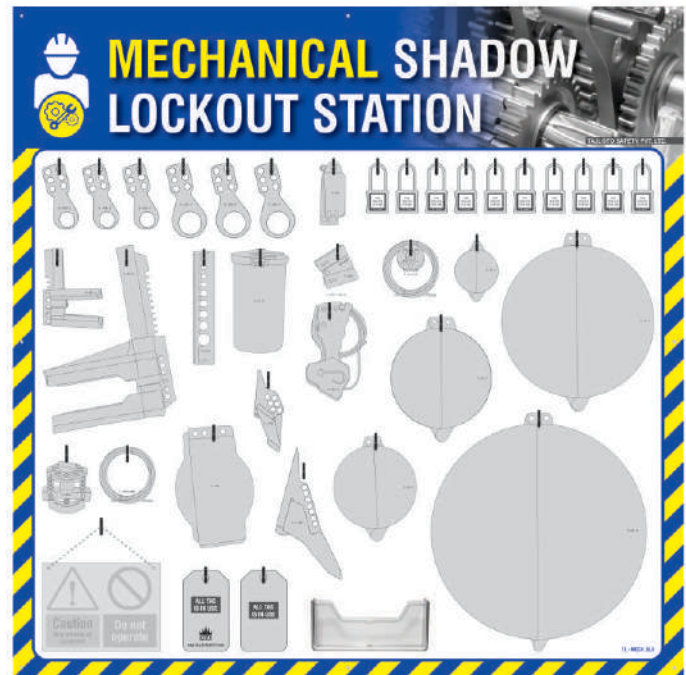

**TL - MECH SLS WG / WOG**  
Taj Loto - MECHANICAL  
Shadow Lockout Station  
(with / without goods)  
Size : 45.5" X 45.5"

### WITH GOODS : Details

1. PVC Coated Hasp - Small \_\_\_\_\_ - 3 nos.
2. PVC Coated Hasp - Premier \_\_\_\_\_ - 3 nos.
3. Premier Lockout Safety Padlock, Steel shackle - Key Different \_\_\_\_\_ - 10 nos.
4. Gate Valve Lockout (GVL - 2) \_\_\_\_\_ - 1 no.
5. Gate Valve Lockout (GVL - 4) \_\_\_\_\_ - 1 no.
6. Gate Valve Lockout (GVL - 6) \_\_\_\_\_ - 1 no.
7. Gate Valve Lockout (GVL - 8) \_\_\_\_\_ - 1 no.
8. Gate Valve Lockout (GVL - 10) \_\_\_\_\_ - 1 no.
9. Gate Valve Adjustable Lockout \_\_\_\_\_ - 1 no.
10. Ball Valve Lockout - 2 (in Top Locking Provision) \_\_\_\_\_ - 1 no.
11. Ball Valve Lockout - 3 Large (in Top Locking Provision) \_\_\_\_\_ - 1 no.
12. Standard - Small - Ball Valve Lockout \_\_\_\_\_ - 1 no.
13. Standard - Large - Ball Valve Lockout \_\_\_\_\_ - 1 no.
14. Universal Butterfly Valve Lockout with Gun Type Cable Lockout and 2 mtrs. Vinyl Coated Steel Cable \_\_\_\_\_ - 1 set
15. Economy Cable Lockout with 2 Mtrs. Vinyl Coated Steel Cable without loop \_\_\_\_\_ - 1 set.
16. Metallic Multipurpose Cable Lockout \_\_\_\_\_ - 1 no.
17. 2 mtrs. Stainless Steel Cable for Metallic Multipurpose Cable Lockout \_\_\_\_\_ - 1 no.
18. Cylinder Lockout Complete Yellow \_\_\_\_\_ - 1 no.
19. Gate Valve Cylinder Lockout \_\_\_\_\_ - 1 no.
20. Pneumatic Lockout Straight with 9 Holes \_\_\_\_\_ - 1 no.
21. Hanging Lockout Sign (6" x 8") \_\_\_\_\_ - 1 no.
22. Taj Loto Tags \_\_\_\_\_ - 20 nos.
23. Nylon Ties for Tags \_\_\_\_\_ - 20 nos.
24. Special Pen with eraser for Tags \_\_\_\_\_ - 1 no.



*Before ordering, please confirm  
Stations are required **with or without goods***

# SHADOW LOCKOUT STATION



**TAJLOTO SAFETY PVT. LTD.**  
LOCKOUT TAGOUT MANUFACTURER

## ELECTRICAL & MECHANICAL SHADOW LOCKOUT STATION

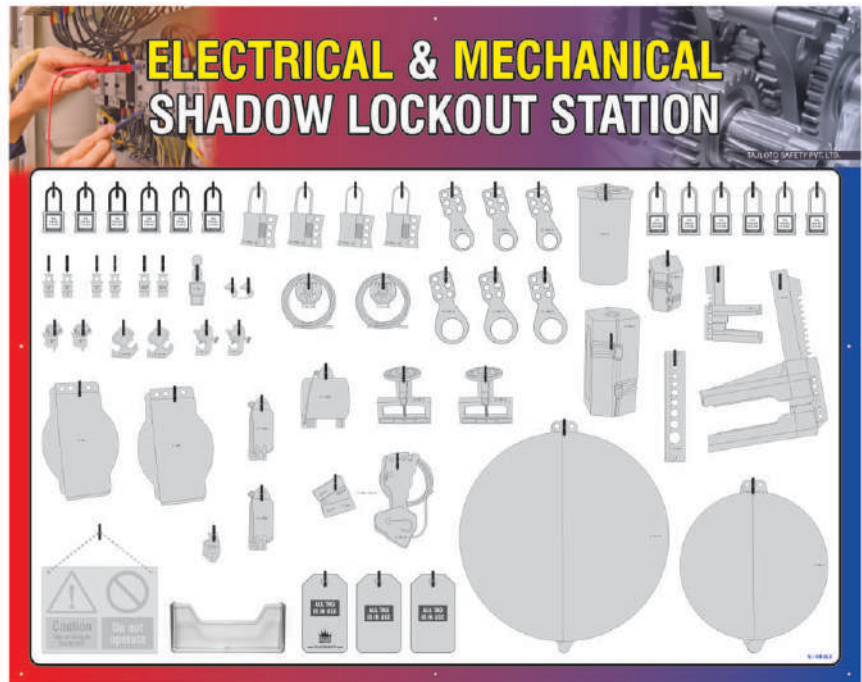

**TL - EM-SLS WG / WOG**  
Taj Loto - ELECTRICAL & MECHANICAL  
Shadow Lockout Station (with / without goods)  
Size : 59.5" X 45.5"

### WITH GOODS : Details >>>

1. PVC Coated Hasp - Small \_\_\_\_\_ - 3 nos.
2. PVC Coated Hasp - Premier \_\_\_\_\_ - 3 nos.
3. Pin & Sleeve Plug Lockout \_\_\_\_\_ - 1 no.
4. De - Electric Slider Hasp for 4 Locks / 3 mm shackle \_\_\_\_\_ - 2 nos.
5. De - Electric Slider Hasp for 4 Locks / 6 mm shackle \_\_\_\_\_ - 2 nos.
6. Premier Lockout Safety Padlock, Steel shackle - Key Different \_\_\_\_\_ - 6 nos.
7. De-Electric Premier Lockout Safety Padlock, Nylon shackle - Key Different \_\_\_\_\_ - 6 nos.
8. PIN-IN, PIN-OUT, PIN-OUT-WIDE & TIE BAR (2 Piece each) \_\_\_\_\_ - 8 nos.
9. Universal Circuit Breaker Lockout, A Tail Type with Twister Screw \_\_\_\_\_ - 2 nos.
10. Universal 2-IN-1 Circuit Breaker Lockout \_\_\_\_\_ - 2 nos.
11. Universal Golden Toggle - Mini Circuit Breaker Lockout \_\_\_\_\_ - 2 nos.
12. Computer Power Cord Lockout \_\_\_\_\_ - 1 no.
13. Small Plug Lockout - Premier \_\_\_\_\_ - 1 no.
14. Large Plug Lockout - Premier \_\_\_\_\_ - 1 no.
15. Large Circuit Breaker Lockout with Round Handle \_\_\_\_\_ - 2 nos.
16. Portable - Emergency Push Button Lockout \_\_\_\_\_ - 2 nos.
17. Universal - Emergency Push Button Lockout \_\_\_\_\_ - 1 no.
18. Gate Valve Lockout (GVL - 8) \_\_\_\_\_ - 1 no.
19. Gate Valve Lockout (GVL - 10) \_\_\_\_\_ - 1 no.
20. Gate Valve Adjustable Lockout \_\_\_\_\_ - 2 nos.
21. Ball Valve Lockout - 2 (in Top Locking Provision) \_\_\_\_\_ - 1 no.
22. Ball Valve Lockout - 3 Large (in Top Locking Provision) \_\_\_\_\_ - 1 no.
23. Universal Butterfly Valve Lockout with Gun Type Cable Lockout and 2 mtrs.  
Vinyl Coated Steel Cable \_\_\_\_\_ - 1 set
24. Economy Cable Lockout with 2 Mtrs. Vinyl Coated Steel Cable without loop \_\_\_\_\_ - 2 set
25. Cylinder Lockout Complete Yellow \_\_\_\_\_ - 1 no.
26. Pneumatic Lockout Straight with 9 Holes \_\_\_\_\_ - 1 no.
27. Hanging Lockout Sign (6" x 8") \_\_\_\_\_ - 1 no.
28. Taj Loto Tags \_\_\_\_\_ - 30 nos.
29. Nylon Ties for Tags \_\_\_\_\_ - 30 nos.
30. Special Pen with eraser for tags \_\_\_\_\_ - 1 no.
31. Screw Driver \_\_\_\_\_ - 1 no.



*Before ordering,  
please confirm Stations are  
required **with or without goods***



## LOCKOUT / TAGOUT KITS

*Lockout Tagout kits allow users to combine and organise regularly used pneumatic, electrical and valve lockout devices. Lockout Kits have been specifically designed for use within various different industries and applications to ensure that workers get the necessary tools to implement and carry out lockout procedures in compliance with OSHA and other lockout regulatory bodies.*

*All the kits can be customized as per your individual requirements and if ordered in volumes\* - Name of the Company / Logo / Department Name etc. can also be printed on these kits.*



DOMESTIC | [tajlotoindia@gmail.com](mailto:tajlotoindia@gmail.com)  
EXPORT | [tajlotoexport@gmail.com](mailto:tajlotoexport@gmail.com)

[tajlotosafety@gmail.com](mailto:tajlotosafety@gmail.com)  
[www.tajlotosafety.in](http://www.tajlotosafety.in)

## ELECTRICAL LOCKOUT KIT - 01



1. Taj Loto - PVC Coated Hasp - Small (TL - PCH - S) \_\_\_\_\_ 1 no.
2. Taj Loto - PVC Coated Hasp - Premier (TL - PCH - P) \_\_\_\_\_ 1 no.
3. Taj Loto - Tight Grip - Circuit Breaker Lockout - Small (TL - G CBL - S) \_\_\_\_\_ 1 no.
4. Taj Loto - De-Electric - Premier Lockout Safety Padlock with 46mm Shackle Height - Key Different - RED (TL - DE-PLSP 46-KD RED) \_\_\_\_\_ 2 nos.
5. Taj Loto - Safety Lockout Tags (TL - TAGS) \_\_\_\_\_ 5 nos.
6. Taj Loto - Nylon Ties (TL - TIES) \_\_\_\_\_ 5 nos.
7. Taj Loto - Pen for Tags and Loto Labels (TL - PEN) \_\_\_\_\_ 1 no.
8. Taj Loto - Lockout Pouch - 05 Black (TL - LP - 05 B) \_\_\_\_\_ 1 no.

Product code : TL - EL Kit - 01

## ELECTRICAL LOCKOUT KIT - 02



1. Taj Loto - Clamp-on Breaker Lockout - Small for 120 / 277 V Breakers (TL - COBL - S) \_\_\_\_\_ 1 no.
2. Taj Loto - Cleat for Small Clamp-on Breaker Lockout (TL - C / COBL - S) \_\_\_\_\_ 1 no.
3. Taj Loto - Universal Multi Pole- Breaker Lockout (TL - UMP-BL) \_\_\_\_\_ 1 no.
4. Taj Loto - Universal Mini Circuit Breaker Lockout - Grip Type (TL - UMCBL - GT) \_\_\_\_\_ 1 no.
5. Taj Loto - Large Plug Lockout - Premier (TL - LPLO - P) \_\_\_\_\_ 1 no.
6. Taj Loto - De-Electric Slider Hasp - 3mm Shackle (TL - DESH 3S) \_\_\_\_\_ 1 no.
7. Taj Loto - De-Electric Slider Hasp - 6mm Shackle (TL - DESH 6S) \_\_\_\_\_ 1 no.
8. Taj Loto - De-Electric - Premier Lockout Safety Padlock with 46mm Shackle Height - Key Different - RED (TL - DE-PLSP 46-KD RED) \_\_\_\_\_ 1 no.
9. Taj Loto - Safety Lockout Tags (TL - TAGS) \_\_\_\_\_ 5 nos.
10. Taj Loto - Nylon Ties (TL - TIES) \_\_\_\_\_ 5 nos.
11. Taj Loto - Pen for Tags and Loto Labels (TL - PEN) \_\_\_\_\_ 1 no.
12. Taj Loto - Lockout Pouch - 05 Black (TL - LP - 05 B) \_\_\_\_\_ 1 no.

Product code : TL - EL Kit - 02

## ELECTRICAL LOCKOUT KIT - 03



1. Taj Loto - Clamp-on Breaker Lockout - Small for 120 / 277 V Breakers (TL - COBL - S) \_\_\_\_\_ 1 no.
2. Taj Loto - Cleat for Small Clamp-on Breaker Lockout (TL - C / COBL - S) \_\_\_\_\_ 1 no.
3. Taj Loto - Clamp-on Breaker Lockout - Medium for 480 / 600 V Breakers (TL - COBL - M) \_\_\_\_\_ 1 no.
4. Taj Loto - Cleat for Medium Clamp-on Breaker Lockout (TL - C / COBL - M) \_\_\_\_\_ 1 no.
5. Taj Loto - Snap-on Circuit Breaker Lockout - Premier (TL - SOCBL - P) \_\_\_\_\_ 2 nos.
6. Taj Loto - Wall Switch Lockout Top Hinge (TL - WSL - TH) \_\_\_\_\_ 1 no.
7. Taj Loto - Large Plug Lockout - Premier (TL - LPLO - P) \_\_\_\_\_ 1 no.
8. Taj Loto - PVC Coated Hasp - Premier (TL - PCH - P) \_\_\_\_\_ 1 no.
9. Taj Loto - Jacket Padlock with Long Shackle - Key Different- Red (TL - JPLS-KD - RED) \_\_\_\_\_ 1 no.
10. Taj Loto - Safety Lockout Tags (TL - TAGS) \_\_\_\_\_ 5 nos.
11. Taj Loto - Nylon Ties (TL - TIES) \_\_\_\_\_ 5 nos.
12. Taj Loto - Pen for Tags and Loto Labels (TL - PEN) \_\_\_\_\_ 1 no.
13. Taj Loto - Lockout Pouch - 01 Red (TL - LP - 01 R) \_\_\_\_\_ 1 no.
14. Taj Loto Booklet (TL - Booklet) \_\_\_\_\_ 1 no.

Product code : TL - EL Kit - 03

## ELECTRICAL LOCKOUT KIT - 04



Product code : TL - EL Kit - 04

1. Taj Loto - Combo Circuit Breaker Lockout (Set of 5) 1 piece of each TL-MCBL-Y, TL-MCBL-GS, TL-UMCBL-B, TL-UMCBL-GT and TL-UBCBL (TL - COMBO Set of 5) \_\_\_\_\_ 1 set.
2. Taj Loto - 1 Piece each of Pin In, Pin Out & Pin Out Wide Standard CBL (TL - COMBO CBL - 3) \_\_\_\_\_ 1 set.
3. Taj Loto - Universal Fuse Holder Lockout - 1 (TL - UNIVERSAL FHL-1) \_\_\_\_\_ 1 no.
4. Taj Loto - Universal Circuit Breaker Lockout - A (TL - UCBL - A) \_\_\_\_\_ 1 no.
5. Taj Loto - Universal Circuit Breaker Lockout - B (TL - UCBL - B) \_\_\_\_\_ 1 no.
6. Taj Loto - Electric - Flexible Lockout Hasp - 3 Hole, 3mm Shackle (TL - E - FLH 33) \_\_\_\_\_ 1 no.
7. Taj Loto - Electric - Flexible Lockout Hasp - 3 Hole, 6mm Shackle (TL - E - FLH 36) \_\_\_\_\_ 1 no.
8. Taj Loto - De-Electric Slider Hasp - 3mm Shackle (TL - DESH 3S) \_\_\_\_\_ 1 no.
9. Taj Loto - De-Electric Slider Hasp - 6mm Shackle (TL - DESH 6S) \_\_\_\_\_ 1 no.
10. Taj Loto - Squeezer Cable Lockout with De-Electric - Yellow Cable, Supplied with 1 meter cable (TL - SCL - DE - Y) \_\_\_\_\_ 1 no.
11. Taj Loto - De-Electric - Premier Lockout Safety Padlock with 46mm Shackle Height- Key Different- RED (TL - DE-PLSP 46-KD RED) \_\_\_\_\_ 2 nos.
12. Taj Loto - Jacket Padlock with Long Shackle - Key Different (TL - JPLS - KD - Set of 3) \_\_\_\_\_ 1 set.
13. Taj Loto - Safety Lockout Tags (TL - TAGS) \_\_\_\_\_ 10 nos.
14. Taj Loto - Nylon Ties (TL - TIES) \_\_\_\_\_ 10 nos.
15. Taj Loto - Pen for Tags and Loto Labels (TL - PEN) \_\_\_\_\_ 1 no.
16. Taj Loto - Screwdriver for Circuit Breaker Lockout (TL - SD FCBL) \_\_\_\_\_ 1 no.
17. Taj Loto - Lockout Pouch - 05 Black (TL - LP - 05 B) \_\_\_\_\_ 1 no.
18. Taj Loto Booklet (TL - Booklet) \_\_\_\_\_ 1 no.

## ELECTRICAL LOCKOUT KIT - 05



Product code : TL - EL Kit - 05

1. Taj Loto - Combo Circuit Breaker Lockout (Set of 5) 1 piece of each TL-MCBL-Y, TL-MCBL-GS, TL-UMCBL-B, TL-UMCBL-GT and TL-UBCBL (TL - COMBO Set of 5) \_\_\_\_\_ 1 set.
2. Taj Loto - 1 Piece each of Pin In, Pin Out, Pin Out Wide Standard CBL (TL - COMBO CBL - 3) \_\_\_\_\_ 1 set.
3. Taj Loto - TIE BAR Standard Circuit Breaker Lockout (TL - TIE BAR CBL) \_\_\_\_\_ 1 no.
4. Taj Loto - Universal Circuit Breaker Lockout - A (TL - UCBL - A) \_\_\_\_\_ 1 no.
5. Taj Loto - Universal Circuit Breaker Lockout - B (TL - UCBL - B) \_\_\_\_\_ 1 no.
6. Taj Loto - Large Circuit Breaker Lockout with Round Handle (TL - LCB - R) \_\_\_\_\_ 1 no.
7. Taj Loto - Squeezer Cable Lockout with De-Electric - Yellow Cable, Supplied with 1mtr. cable (TL - SCL - DE - Y) \_\_\_\_\_ 1 no.
8. Taj Loto - Electric - Flexible Lockout Hasp - 3 Hole, 3mm Shackle (TL - E - FLH 33) \_\_\_\_\_ 1 no.
9. Taj Loto - Electric - Flexible Lockout Hasp - 3 Hole, 6mm Shackle (TL - E - FLH 36) \_\_\_\_\_ 1 no.
10. Taj Loto - Electric - Flexible Lockout Hasp - 6 Hole, 6mm Shackle (TL - E - FLH 66) \_\_\_\_\_ 1 no.
11. Taj Loto - De-Electric - Premier Lockout Safety Padlock with 46mm Shackle Height - Same Key - Red (TL - DE-PLSP 46-SK Red) \_\_\_\_\_ 1 no.
12. Taj Loto - De-Electric - Premier Lockout Safety Padlock with 46mm Shackle Height - Same Key (TL - DE-PLSP 46-SK Yellow) \_\_\_\_\_ 1 no.
13. Taj Loto - Safety Lockout Tags (TL - TAGS) \_\_\_\_\_ 5 nos.
14. Taj Loto - Nylon Ties (TL - TIES) \_\_\_\_\_ 5 nos.
15. Taj Loto - Pen for Tags and Loto Labels (TL - PEN) \_\_\_\_\_ 1 no.
16. Taj Loto - Screwdriver for Circuit Breaker Lockout (TL - SD FCBL) \_\_\_\_\_ 1 no.
17. Taj Loto - 03 Lockout Pouch - 01 Red (TL - LP - 01 R) \_\_\_\_\_ 1 no.
18. Taj Loto Booklet (TL - Booklet) \_\_\_\_\_ 1 no.

## ELECTRICAL LOCKOUT KIT - 06



Product code : TL - EL Kit - 06

1. Taj Loto - Combo Circuit Breaker Lockout (Set of 5) 1 piece of each TL-MCBL-Y, TL-MCBL-GS, TL-UMCBL-B, TL-UMCBL-GT and TL-UBCBL (TL - COMBO Set of 5) \_\_\_\_\_ 1 set.
2. Taj Loto - 1 Piece each of Pin In, Pin Out, Pin Out Wide Standard CBL (TL - COMBO CBL - 3) \_\_\_\_\_ 1 set.
3. Taj Loto - TIE BAR Standard Circuit Breaker Lockout (TL - TIE BAR CBL) \_\_\_\_\_ 1 no.
4. Taj Loto - Universal Circuit Breaker Lockout - A (TL - UCBL - A) \_\_\_\_\_ 1 no.
5. Taj Loto - Universal Circuit Breaker Lockout - B (TL - UCBL - B) \_\_\_\_\_ 1 no.
6. Taj Loto - Large Circuit Breaker Lockout with Round Handle (TL - LCB - R) \_\_\_\_\_ 1 no.
7. Taj Loto - Squeezer Cable Lockout with De-Electric - Yellow Cable, Supplied with 1 meter cable (TL - SCL - DE - Y) \_\_\_\_\_ 1 no.
8. Taj Loto - Electric - Flexible Lockout Hasp - 3 Hole, 3mm Shackle (TL - E - FLH 33) \_\_\_\_\_ 1 no.
9. Taj Loto - Electric - Flexible Lockout Hasp - 3 Hole, 6mm Shackle (TL - E - FLH 36) \_\_\_\_\_ 1 no.
10. Taj Loto - Electric - Flexible Lockout Hasp - 6 Hole, 6mm Shackle (TL - E - FLH 66) \_\_\_\_\_ 1 no.
11. Taj Loto - De-Electric - Premier Lockout Safety Padlock with 46mm Shackle Height - Same Key - Red (TL - DE-PLSP 46- SK Red) \_\_\_\_\_ 1 no.
12. Taj Loto - De-Electric - Premier Lockout Safety Padlock with 46mm Shackle Height - Same Key (TL - DE-PLSP 46 - SK Yellow) \_\_\_\_\_ 1 no.
13. Taj Loto - Safety Lockout Tags (TL - TAGS) \_\_\_\_\_ 5 nos.
14. Taj Loto - Nylon Ties (TL - TIES) \_\_\_\_\_ 5 nos.
15. Taj Loto - Pen for Tags and Loto Labels (TL - PEN) \_\_\_\_\_ 1 no.
16. Taj Loto - Screwdriver for Circuit Breaker Lockout (TL - SD FCBL) \_\_\_\_\_ 1 no.
17. Taj Loto - Lockout Pouch - 05 Yellow (TL - LP - 05 Y) \_\_\_\_\_ 1 no.
18. Taj Loto Booklet (TL - Booklet) \_\_\_\_\_ 1 no.

## ELECTRICAL LOCKOUT KIT - 07



Product code : TL - EL Kit - 07

1. Taj Loto - Electric - Flexible Lockout Hasp - 3 Hole, 3mm Shackle (TL - E - FLH 33) \_\_\_\_\_ 1 no.
2. Taj Loto - Electric - Flexible Lockout Hasp - 3 Hole, 6mm Shackle (TL - E - FLH 36) \_\_\_\_\_ 1 no.
3. Taj Loto - Electric - Flexible Lockout Hasp - 6 Hole, 6mm Shackle (TL - E - FLH 66) \_\_\_\_\_ 1 no.
4. Taj Loto - Universal Circuit Breaker Lockout - A (TL - UCBL - A) \_\_\_\_\_ 1 no.
5. Taj Loto - Universal Circuit Breaker Lockout - B (TL - UCBL - B) \_\_\_\_\_ 1 no.
6. Taj Loto - Large Circuit Breaker Lockout with Round Handle (TL - LCB - R) \_\_\_\_\_ 1 no.
7. Taj Loto - Squeezer Cable Lockout with De-Electric - Yellow Cable, Supplied with 1 meter cable (TL - SCL - DE - Y) \_\_\_\_\_ 1 no.
8. Taj Loto - Combo Circuit Breaker Lockout (Set of 5) 1 piece of each TL-MCBL-Y, TL-MCBL-GS, TL-UMCBL-B, TL-UMCBL-GT and TL-UBCBL (TL - COMBO Set of 5) \_\_\_\_\_ 1 set.
9. Taj Loto - 1 Piece each of Pin In, Pin Out, Pin Out Wide Standard CBL (TL - COMBO CBL - 3) \_\_\_\_\_ 1 set.
10. Taj Loto - TIE BAR Standard Circuit Breaker Lockout (TL - TIE BAR CBL) \_\_\_\_\_ 1 no.
11. Taj Loto - De-Electric - Premier Lockout Safety Padlock with 46mm Shackle Height - Same Key (TL - DE-PLSP 46-SK Red) \_\_\_\_\_ 1 no.
12. Taj Loto - De-Electric - Premier Lockout Safety Padlock with 46mm Shackle Height - Same Key (TL - DE-PLSP 46-SK Yellow) \_\_\_\_\_ 1 no.
13. Taj Loto - Safety Lockout Tags (TL - TAGS) \_\_\_\_\_ 5 nos.
14. Taj Loto - Nylon Ties (TL - TIES) \_\_\_\_\_ 5 nos.
15. Taj Loto - Pen for Tags and Loto Labels (TL - PEN) \_\_\_\_\_ 1 no.
16. Taj Loto - Screwdriver for Circuit Breaker Lockout (TL - SD FCBL) \_\_\_\_\_ 1 no.
17. Taj Loto - Lockout 3Pocket Belt Pouch - Red (TL - L3PBP - R) \_\_\_\_\_ 1 no.
18. Taj Loto Booklet (TL - Booklet) \_\_\_\_\_ 1 no.

## ELECTRICAL DEPARTMENT LOCKOUT KIT - 08



Product code : TL - ED LOTO Kit - 8

1. Taj Loto - Combo Circuit Breaker Lockout (Set of 5) 1 piece of each TL-MCBL-Y, TL-MCBL-GS, TL-UMCBL-B, TL-UMCBL-GT and TL-UBCBL (TL - COMBO Set of 5) \_\_\_\_\_ 1 Set
2. Taj Loto - 1 Piece each of Pin In, Pin Out, Pin Out Wide Standard CBL (TL - COMBO CBL - 3) \_\_\_\_\_ 1 Set
3. Taj Loto - TIE BAR Standard Circuit Breaker Lockout (TL - TIE BAR CBL) \_\_\_\_\_ 1 no.
4. Taj Loto - Universal Circuit Breaker Lockout - A (TL - UCBL - A) \_\_\_\_\_ 1 no.
5. Taj Loto - Universal Circuit Breaker Lockout - B (TL - UCBL - B) \_\_\_\_\_ 1 no.
6. Taj Loto - Large Circuit Breaker Lockout with Round Handle (TL - LCB - R) \_\_\_\_\_ 1 no.
7. Taj Loto - Small Plug Lockout - Premier (TL - SPLO - P) \_\_\_\_\_ 1 no.
8. Taj Loto - Large Plug Lockout - Premier (TL - LPLO - P) \_\_\_\_\_ 1 no.
9. Taj Loto - Cylinder Electrical - Plug Lockout (TL - CE - PL) \_\_\_\_\_ 1 no.
10. Taj Loto - Squeezer Cable Lockout with De-Electric - Yellow Cable, Supplied with 1 meter cable (TL - SCL - DE - Y) \_\_\_\_\_ 1 no.
11. Taj Loto - Economy Cable Lockout with 2 meter Vinyl Coated Steel Cable without Loop (TL - ECL+2C WL) \_\_\_\_\_ 1 Set
12. Taj Loto - De-Electric Slider Hasp - 3mm Shackle (TL - DESH 3S) \_\_\_\_\_ 1 no.
13. Taj Loto - De-Electric Slider Hasp - 6mm Shackle (TL - DESH 6S) \_\_\_\_\_ 1 no.
14. Taj Loto - Electric - Flexible Lockout Hasp - 3 Hole, 3mm Shackle (TL - E - FLH 33) \_\_\_\_\_ 2 nos.
15. Taj Loto - Electric - Flexible Lockout Hasp - 3 Hole, 6mm Shackle (TL - E - FLH 36) \_\_\_\_\_ 2 nos.
16. Taj Loto - Electric - Flexible Lockout Hasp - 6 Hole, 6mm Shackle (TL - E - FLH 66) \_\_\_\_\_ 2 nos.
17. Taj Loto - Electrical Panel Lockout - Round 45 (TL - EPL - R45) \_\_\_\_\_ 1 no.
18. Taj Loto - Electrical Panel Lockout - Round 55 (TL - EPL - R55) \_\_\_\_\_ 1 no.
19. Taj Loto - Electrical Panel Lockout - SMALL (TL - EPL - S) \_\_\_\_\_ 1 no.
20. Taj Loto - Electrical Panel Lockout - MEDIUM (TL - EPL - M) \_\_\_\_\_ 1 no.
21. Taj Loto - Electrical Panel Lockout - MEDIUM 45° Degree Cutout (TL - EPL - M 45 DC) \_\_\_\_\_ 1 no.
22. Taj Loto - Electrical Panel Lockout - MEDIUM 90° Degree Cutout (TL - EPL - M 90 DC) \_\_\_\_\_ 1 no.
23. Taj Loto - Handle Lockout of Electrical Panel with De-electric Strip (TL - HLEP - 1 DS) \_\_\_\_\_ 1 no.
24. Taj Loto - De-Electric - Premier Lockout Safety Padlock with 46mm Shackle Height - Key Different (TL - DE-PLSP 46- KD Red) \_\_\_\_\_ 3 nos.
25. Taj Loto - De-Electric - PLSP with 46mm Shackle Height - Same Key (TL - DE-PLSP 46- SK Yellow) Set of 2 \_\_\_\_\_ 1 Set.
26. Taj Loto - Safety Lockout Tags (TL - TAGS) \_\_\_\_\_ 20 nos.
27. Taj Loto - Nylon Ties (TL - TIES) \_\_\_\_\_ 20 nos.
28. Taj Loto - Pen for Tags and Loto Labels (TL - PEN) \_\_\_\_\_ 1 no.
29. Taj Loto - Screwdriver for Circuit Breaker Lockout (TL - SD FCBL) \_\_\_\_\_ 1 no.
30. Taj Loto - Lockout Bag Red & Yellow - Medium (TL - LB R&Y - M) \_\_\_\_\_ 1 no.
31. Taj Loto Booklet (TL - Booklet) \_\_\_\_\_ 1 no.

## ELECTRICAL LOCKOUT KIT - 09



Product code : TL - EL Kit - 09

1. Taj Loto - Premier Lockout Safety Padlock with 46mm Shackle Height - Key Different - Set of 3 (TL - PLSP 46 - KD) \_\_\_\_\_ 1 Set.
2. Taj Loto - PVC Coated Hasp - Small (TL - PCH - S) \_\_\_\_\_ 1 no.
3. Taj Loto - Safety Lockout Tags (TL - TAGS) \_\_\_\_\_ 10 nos.
4. Taj Loto - Nylon Ties (TL - TIES) \_\_\_\_\_ 10 nos.
5. Taj Loto - Pen for Tags and Loto Labels (TL - PEN) \_\_\_\_\_ 1 no.
6. Taj Loto - Lockout 1Pocket Belt Pouch - Red (TL - L1PBP - R) \_\_\_\_\_ 1 no.

## ELECTRICAL DEPARTMENT LOCKOUT KIT - 10



Product code : **TL - ED LOTO Kit - 10**

1. Taj Loto - Combo Circuit Breaker Lockout (Set of 5) 1 piece of each TL-MCBL-Y, TL-MCBL-GS, TL-UMCBL-B, TL-UMCBL-GT and TL-UBCBL (TL - COMBO Set of 5) \_\_\_\_\_ 1 Set
2. Taj Loto - 1 Piece each of Pin In, Pin Out, Pin Out Wide Standard CBL (TL - COMBO CBL - 3) \_\_\_\_\_ 1 Set
3. Taj Loto - TIE BAR Standard Circuit Breaker Lockout (TL- TIE BAR CBL) \_\_\_\_\_ 1 no.
4. Taj Loto - Universal Circuit Breaker Lockout - A (TL - UCBL - A) \_\_\_\_\_ 1 no.
5. Taj Loto - Universal Circuit Breaker Lockout - B (TL - UCBL - B) \_\_\_\_\_ 1 no.
6. Taj Loto - Large Circuit Breaker Lockout with Round Handle (TL - LCB - R) \_\_\_\_\_ 1 no.
7. Taj Loto - Small Plug Lockout - Premier (TL - SPLO - P) \_\_\_\_\_ 1 no.
8. Taj Loto - Large Plug Lockout - Premier (TL - LPLO - P) \_\_\_\_\_ 1 no.
9. Taj Loto - Cylinder Electrical - Plug Lockout (TL - CE - PL) \_\_\_\_\_ 1 no.
10. Taj Loto - Squeezer Cable Lockout with De-Electric - Yellow Cable, Supplied with 1 meter cable (TL - SCL - DE - Y) \_\_\_\_\_ 1 no.
11. Taj Loto - Economy Cable Lockout with 2 meter Vinyl Coated Steel Cable without Loop (TL - ECL+2C WL) \_\_\_\_\_ 1 Set
12. Taj Loto - De-Electric Slider Hasp - 3mm Shackle (TL - DESH 3S) \_\_\_\_\_ 1 no.
13. Taj Loto - De-Electric Slider Hasp - 6mm Shackle (TL - DESH 6S) \_\_\_\_\_ 1 no.
14. Taj Loto - Electric - Flexible Lockout Hasp - 3 Hole, 3mm Shackle (TL - E - FLH 33) \_\_\_\_\_ 2 nos.
15. Taj Loto - Electric - Flexible Lockout Hasp - 3 Hole, 6mm Shackle (TL - E - FLH 36) \_\_\_\_\_ 2 nos.
16. Taj Loto - Electric - Flexible Lockout Hasp - 6 Hole, 6mm Shackle (TL - E - FLH 66) \_\_\_\_\_ 2 nos.
17. Taj Loto - Electric - Flexible Lockout Hasp - 6 Hole, 5mm Shackle (TL - E - FLH 65) \_\_\_\_\_ 2 nos.
18. Taj Loto - Electrical Panel Lockout - Round 45 (TL - EPL - R45) \_\_\_\_\_ 1 no.
19. Taj Loto - Electrical Panel Lockout - Round 55 (TL - EPL - R55) \_\_\_\_\_ 1 no.
20. Taj Loto - Electrical Panel Lockout - SMALL (TL - EPL - S) \_\_\_\_\_ 1 no.
21. Taj Loto - Electrical Panel Lockout - MEDIUM (TL - EPL - M) \_\_\_\_\_ 1 no.
22. Taj Loto - Electrical Panel Lockout - MEDIUM 45° Degree Cutout (TL - EPL - M 45 DC) \_\_\_\_\_ 1 no.
23. Taj Loto - Electrical Panel Lockout - MEDIUM 90° Degree Cutout (TL - EPL - M 90 DC) \_\_\_\_\_ 1 no.
24. Taj Loto - Handle Lockout of Electrical Panel with De-electric Strip (TL - HLEP - 1 DS) \_\_\_\_\_ 1 no.
25. Taj Loto - De-Electric - Premier Lockout Safety Padlock with 46mm Shackle Height - Key Different (TL - DE-PLSP 46- KD Red) \_\_\_\_\_ 3 nos.
26. Taj Loto - De-Electric - PLSP with 46mm Shackle Height - Same Key (TL - DE-PLSP 46- SK Yellow) Set of 2 \_\_\_\_\_ 1 Set.
27. Taj Loto - Safety Lockout Tags (TL - TAGS) \_\_\_\_\_ 20 nos.
28. Taj Loto - Nylon Ties (TL - TIES) \_\_\_\_\_ 20 nos.
29. Taj Loto - Pen for Tags and Loto Labels (TL - PEN) \_\_\_\_\_ 1 no.
30. Taj Loto - Screwdriver for Circuit Breaker Lockout (TL - SD FCBL) \_\_\_\_\_ 1 no.
31. Taj Loto - Lockout Tagout Station-1 in Clear Front (TL-LTS-1 CF) \_\_\_\_\_ 1 no.
32. Taj Loto Booklet (TL - Booklet) \_\_\_\_\_ 1 no.

## ELECTRICAL DEPARTMENT LOCKOUT KIT - 11



Product code : TL - EL Kit - 11

1. Taj Loto - Combo Circuit Breaker Lockout (Set of 5) 1 piece of each TL-MCBL-Y, TL-MCBL-GS, TL-UMCBL-B, TL-UMCBL-GT and TL-UBCBL (TL - COMBO Set of 5) \_\_\_\_\_ 1 set.
2. Taj Loto - 1 Piece each of Pin In, Pin Out, Pin Out Wide Standard CBL (TL - COMBO CBL - 3) \_\_\_\_\_ 1 set.
3. Taj Loto - TIE BAR Standard Circuit Breaker Lockout (TL - TIE BAR CBL) \_\_\_\_\_ 1 no.
4. Taj Loto - Universal Circuit Breaker Lockout - A (TL - UCBL - A) \_\_\_\_\_ 1 no.
5. Taj Loto - Universal Circuit Breaker Lockout - B (TL - UCBL - B) \_\_\_\_\_ 1 no.
6. Taj Loto - Large Circuit Breaker Lockout with Round Handle (TL - LCB - R) \_\_\_\_\_ 1 no.
7. Taj Loto - Squeezer Cable Lockout with De-Electric - Yellow Cable, Supplied with 1 meter cable (TL - SCL - DE - Y) \_\_\_\_\_ 1 no.
8. Taj Loto - Electric - Flexible Lockout Hasp - 3 Hole, 3mm Shackle (TL - E - FLH 33) \_\_\_\_\_ 1 no.
9. Taj Loto - Electric - Flexible Lockout Hasp - 3 Hole, 6mm Shackle (TL - E - FLH 36) \_\_\_\_\_ 1 no.
10. Taj Loto - Electric - Flexible Lockout Hasp - 6 Hole, 6mm Shackle (TL - E - FLH 66) \_\_\_\_\_ 1 no.
11. Taj Loto - Electric - Flexible Lockout Hasp - 6 Hole, 5mm Shackle (TL - E - FLH 65) \_\_\_\_\_ 1 no.
12. Taj Loto - De-Electric - Premier Lockout Safety Padlock with 46mm Shackle Height - Same Key - Red (TL - DE-PLSP 46- SK Red) \_\_\_\_\_ 1 no.
13. Taj Loto - De-Electric - Premier Lockout Safety Padlock with 46mm Shackle Height - Same Key (TL - DE-PLSP 46 - SK Yellow) \_\_\_\_\_ 1 nos.
14. Taj Loto - Safety Lockout Tags (TL - TAGS) \_\_\_\_\_ 5 nos.
15. Taj Loto - Nylon Ties (TL - TIES) \_\_\_\_\_ 5 no.
16. Taj Loto - Pen for Tags and Loto Labels (TL - PEN) \_\_\_\_\_ 1 no.
17. Taj Loto - Screwdriver for Circuit Breaker Lockout (TL - SD FCBL) \_\_\_\_\_ 1 no.
15. Taj Loto - Group Lock Box - Red 13 Hole (TL - -GLB - R 13H) \_\_\_\_\_ 1 no

# LOCKOUT KITS



**TAJLOTO SAFETY PVT. LTD.**  
LOCKOUT TAGOUT MANUFACTURER

## PREMIER LOCKOUT KIT - 01



1. Taj Loto - PVC Coated Hasp - Small (TL - PCH - S) \_\_\_\_\_ 1 no.
2. Taj Loto - PVC Coated Hasp - Premier (TL - PCH - P) \_\_\_\_\_ 1 no.
3. Taj Loto - Jacket Padlock with Long Shackle - Key Different- Red Colour (TL - LPRS - KD) \_\_\_\_\_ 1 no.
4. Taj Loto - Jacket Padlock with Long Shackle - Key Different- Yellow Colour (TL - JPLS - KD) \_\_\_\_\_ 1 no.
5. Taj Loto - Safety Lockout Tags (TL - TAGS) \_\_\_\_\_ 2 nos.
6. Taj Loto - Nylon Ties (TL - TIES) \_\_\_\_\_ 2 nos.
7. Taj Loto - Pen for Tags and Loto Labels (TL - PEN) \_\_\_\_\_ 1 no.
8. Taj Loto - Lockout 1 Pocket Belt Pouch - Red (TL - L1PBP - R) \_\_\_\_\_ 1 no.

Product code : TL - PL Kit - 01

## PREMIER LOCKOUT KIT - 02



1. Taj Loto - Cylinder Lockout - Full (TL - CL - Full) \_\_\_\_\_ 1 no.
2. Taj Loto - Cylinder Lockout - Empty (TL - CL - Empty) \_\_\_\_\_ 1 no.
3. Taj Loto - Gate Valve Lockout - 2 (TL - GVL - 2) \_\_\_\_\_ 1 no.
4. Taj Loto - Gate Valve Lockout - 4 (TL - GVL - 4) \_\_\_\_\_ 1 no.
5. Taj Loto - Ball Valve Lockout-1 in Side Locking (TL - BVL-1) \_\_\_\_\_ 1 no.
6. Taj Loto - PVC Coated Hasp - Small (TL - PCH - S) \_\_\_\_\_ 1 no.
7. Taj Loto - PVC Coated Hasp - Premier (TL - PCH - P) \_\_\_\_\_ 1 no.
8. Taj Loto - Red Powder Coated Scorpio Hasp (TL-RPC SCORPIO) - \_\_\_\_\_ 1 no.
9. Taj Loto - Electric - Flexible Lockout Hasp - 3 Hole, 3mm Shackle (TL - E - FLH 33) \_\_\_\_\_ 1 no.
10. Taj Loto - Electric - Flexible Lockout Hasp - 3 Hole, 6mm Shackle (TL - E - FLH 36) \_\_\_\_\_ 1 no.
11. Taj Loto - Electric - Flexible Lockout Hasp - 6 Hole, 6mm Shackle (TL - E - FLH 66) \_\_\_\_\_ 1 no.
12. Taj Loto - Electric Flexible Lockout Hasp - 6 Hole, 5.5mm Shackle (TL - E - FLH 65) \_\_\_\_\_ 1 no.
13. Taj Loto - Combo Circuit Breaker Lockout (Set of 5) 1 piece of each TL-MCBL-Y, TL-MCBL-GS, TL-UMCBL-B, TL-UMCBL-GT and TL-UBCBL (TL - COMBO Set of 5) \_\_\_\_\_ 1 set.
14. Taj Loto - 1 Piece each of Pin In, Pin Out, Pin Out Wide Standard CBL (TL - COMBO CBL - 3) \_\_\_\_\_ 1 set.
15. Taj Loto - Universal Circuit Breaker Lockout - A (TL - UCBL - A) \_\_\_\_\_ 1 no.
16. Taj Loto - Universal Circuit Breaker Lockout - B (TL - UCBL - B) \_\_\_\_\_ 1 no.
17. Taj Loto - Large CBL with Round Handle (TL - LCB - R) \_\_\_\_\_ 1 no.
18. Taj Loto - Small Plug Lockout - Premier (TL - SPLO - P) \_\_\_\_\_ 1 no.
19. Taj Loto - Squeezer Cable Lockout with Metallic Blue Cable, Supplied with 1 meter cable (TL - SCL - MB) \_\_\_\_\_ 1 no.
20. Taj Loto - Economy Cable Lockout with 2 meter Vinyl Coated Steel Cable without Loop (TL - ECL+2C WL) \_\_\_\_\_ 1 set.
21. Taj Loto - De-Electric - Premier Lockout Safety Padlock with 46mm Shackle Height - Key Different (TL - DE-PLSP 46- KD Red) \_\_\_\_\_ 2 nos.
22. Taj Loto - Jacket Padlock with Long Shackle - Key Different- Yellow Colour (TL - JPLS - KD) \_\_\_\_\_ 3 nos.
23. Taj Loto - Safety Lockout Tags (TL - TAGS) \_\_\_\_\_ 10 nos.
24. Taj Loto - Nylon Ties (TL - TIES) \_\_\_\_\_ 10 nos.
25. Taj Loto - Pen for Tags and Loto Labels (TL - PEN) \_\_\_\_\_ 1 no.
26. Taj Loto - Lockout Bag Red & Yellow - Small (TL - LB R&Y - S) \_\_\_\_\_ 1 no.
27. Taj Loto Booklet (TL - Booklet) \_\_\_\_\_ 1 no.

Product code : TL - PL Kit - 02

## PREMIER LOCKOUT KIT - 03



Product code : TL - PL Kit - 03

1. Taj Loto - De-Electric Slider Hasp- 3mm Shackle (TL - DESH 3S) — 1 no.
2. Taj Loto - De-Electric Slider Hasp- 6mm Shackle (TL - DESH 6S) — 1 no.
3. Taj Loto - Red Powder Coated Scorpio Hasp (TL-RPC SCORPIO) — 1 no.
4. Taj Loto - PVC Coated Hasp - Small (TL - PCH - S) — 1 no.
5. Taj Loto - PVC Coated Hasp - Premier (TL - PCH - P) — 1 no.
6. Taj Loto - Jacket Padlock with Regular Shackle - Key Different - Red & Yellow Colour (TL - JPRS - KD) — 2 nos.
7. Taj Loto - Jacket Padlock with Long Shackle - Key Different- Red & Yellow Colour (TL - JPLS - KD) — 2 nos.
8. Taj Loto - Safety Lockout Tags (TL - TAGS) — 10 nos.
9. Taj Loto - Nylon Ties (TL - TIES) — 10 nos.
10. Taj Loto - Pen for Tags and Loto Labels (TL - PEN) — 1 no.
11. Taj Loto - Lockout 3Pocket Belt Pouch - Red (TL - L3PBP - R) — 1 no.
12. Taj Loto Booklet (TL - Booklet) — 1 no.

## PREMIER LOCKOUT KIT - 04



Product code : TL - PL Kit - 04

1. Taj Loto - Cylinder Lockout - Full (TL - CL - Full) — 1 no.
2. Taj Loto - Cylinder Lockout - Empty (TL - CL - Empty) — 1 no.
3. Taj Loto - Gate Valve Lockout - 2 (TL - GVL - 2) — 1 no.
4. Taj Loto - Gate Valve Lockout - 4 (TL - GVL - 4) — 1 no.
5. Taj Loto - Ball Valve Lockout-1 in Side Locking (TL - BVL-1) — 1 no.
6. Taj Loto - PVC Coated Hasp - Small (TL - PCH - S) — 1 no.
7. Taj Loto - PVC Coated Hasp - Premier (TL - PCH - P) — 1 no.
8. Taj Loto - Red Powder Coated Scorpio Hasp (TL-RPC SCORPIO) — 1 no.
9. Taj Loto - Electric - Flexible Lockout Hasp - 3 Hole, 3mm Shackle (TL - E - FLH 33) — 1 no.
10. Taj Loto - Electric - Flexible Lockout Hasp - 3 Hole, 6mm Shackle (TL - E - FLH 36) — 1 no.
11. Taj Loto - Electric - Flexible Lockout Hasp - 6 Hole, 6mm Shackle (TL - E - FLH 66) — 1 no.
12. Taj Loto - Electric Flexible Lockout Hasp - 6 Hole, 5.5mm Shackle (TL - E - FLH 65) — 1 no.
13. Taj Loto - Combo Circuit Breaker Lockout (Set of 5) 1 piece of each TL-MCBL-Y, TL-MCBL-GS, TL-UMCBL-B, TL-UMCBL-GT and TL-UBCBL (TL - COMBO Set of 5) — 1 set.
14. Taj Loto - 1 Piece each of Pin In, Pin Out, Pin Out Wide Standard CBL (TL - COMBO CBL - 3) — 1 set.
15. Taj Loto - Universal Circuit Breaker Lockout - A (TL - UCBL - A) — 1 no.
16. Taj Loto - Universal Circuit Breaker Lockout - B (TL - UCBL - B) — 1 no.
17. Taj Loto - Large CBL with Round Handle (TL - LCB - R) — 1 no.
18. Taj Loto - Small Plug Lockout - Premier (TL - SPLO - P) — 1 no.
19. Taj Loto - Squeezer Cable Lockout with Metallic Blue Cable, Supplied with 1 meter cable (TL - SCL - MB) — 1 no.
20. Taj Loto - Economy Cable Lockout with 2 meter Vinyl Coated Steel Cable without Loop (TL - ECL+2C WL) — 1 set.
21. Taj Loto - De-Electric - Premier Lockout Safety Padlock with 46mm Shackle Height - Key Different (TL - DE-PLSP 46- KD Red) — 2 nos.
22. Taj Loto - Jacket Padlock with Long Shackle - Key Different- Yellow Colour (TL - JPLS - KD) — 3 nos.
23. Taj Loto - Safety Lockout Tags (TL - TAGS) — 10 nos.
24. Taj Loto - Nylon Ties (TL - TIES) — 10 nos.
25. Taj Loto - Pen for Tags and Loto Labels (TL - PEN) — 1 no.
26. Taj Loto - Lockout Tagout Station-1 in Clear Front (TL-LTS-1 CF) — 1 no.
27. Taj Loto Booklet (TL - Booklet) — 1 no.

## PREMIER LOCKOUT KIT - 05



Product code : TL - PL Kit - 05

1. Taj Loto - PVC Coated Hasp - Small (TL - PCH - S) \_\_\_\_\_ 2 nos.
2. Taj Loto - PVC Coated Hasp - Premier (TL - PCH - P) \_\_\_\_\_ 2 nos.
3. Taj Loto - Red Powder Coated Scorpio Hasp (TL - RPC SCORPIO) – 1 no.
4. Taj Loto - Jacket Padlock with Regular Shackle - Key Different - Red & Blue Colour (TL - JPRS - KD) \_\_\_\_\_ 2 nos.
5. Taj Loto - Jacket Padlock with Long Shackle - Key Different - Red & Blue Colour (TL - JPLS - KD) \_\_\_\_\_ 2 nos.
6. Taj Loto - Safety Lockout Tags (TL - TAGS) \_\_\_\_\_ 10 nos.
7. Taj Loto - Nylon Ties (TL - TIES) \_\_\_\_\_ 10 nos.
8. Taj Loto - Pen for Tags and Loto Labels (TL - PEN) \_\_\_\_\_ 1 no.
9. Taj Loto - Lockout Pouch - 03 Red (TL - LP - 03 R) \_\_\_\_\_ 1 no.
10. Taj Loto Booklet (TL - Booklet) \_\_\_\_\_ 1 no.

## PREMIER LOCKOUT KIT - 06



Product code : TL - PL Kit - 06

1. Taj Loto - Cylinder Lockout - Complete Yellow (TL - CL - CY) \_\_\_\_\_ 1 no.
2. Taj Loto - Gate Valve Adjustable Lockout (TL - GVAL) \_\_\_\_\_ 1 no.
3. Taj Loto - Cylinder Lockout - Empty (TL - CL Empty) \_\_\_\_\_ 1 no.
4. Taj Loto - Gate Valve Lockout - 2 (TL - GVL - 2) \_\_\_\_\_ 1 no.
5. Taj Loto - Ball Valve Lockout-1 in Side Locking (TL - BVL-1) \_\_\_\_\_ 1 no.
6. Taj Loto - Ball Valve Lockout-1 in Side Locking (TL - S - LBVL) \_\_\_\_\_ 1 no.
7. Taj Loto - PVC Coated Hasp - Small (TL - PCH - S) \_\_\_\_\_ 1 no.
8. Taj Loto - PVC Coated Hasp - Premier (TL - PCH - P) \_\_\_\_\_ 1 no.
9. Taj Loto - Electric - Flexible Lockout Hasp - 3 Hole, 3mm Shackle (TL - E - FLH 33) \_\_\_\_\_ 1 no.
10. Taj Loto - Electric - Flexible Lockout Hasp - 6 Hole, 6mm Shackle (TL - E - FLH 66) \_\_\_\_\_ 1 no.
11. Taj Loto - Electrical Panel Lockout - Round 45 (TL-EPL-R45) \_\_\_\_\_ 1 no.
12. Electrical Panel Lockout -Small (TL - EPL - S) \_\_\_\_\_ 1 no.
13. Electrical Panel Lockout -Medium (TL - EPL - M) \_\_\_\_\_ 1 no.
14. Taj Loto - Combo Circuit Breaker Lockout (Set of 5) 1 piece of each TL-MCBL-Y, TL-MCBL-GS, TL-UMCBL-B, TL-UMCBL-GT and TL-UBCBL (TL - COMBO Set of 5) \_\_\_\_\_ 1 set.
15. Taj Loto - 1 Piece each of Pin in, Pin Out, Wide Standard CBL (TL - COMBO CBL - 3) \_\_\_\_\_ 1 no.
16. Taj Loto - Universal Circuit Breaker Lockout - A (TL - UCBL - A) \_\_\_\_\_ 1 no.
17. Taj Loto - Universal Circuit Breaker Lockout - B (TL - UCBL - B) \_\_\_\_\_ 1 no.
18. Taj Loto - Large CBL with Round Handle (TL - LCB - R) \_\_\_\_\_ 1 no.
19. Taj Loto - Small Plug Lockout - Premier (TL - SPLO - P) \_\_\_\_\_ 1 no.
20. Taj Loto - Squeezer Cable Lockout with Metallic Blue Cable, Supplied with 1 meter cable (TL - SCL - MB) \_\_\_\_\_ 1 no.
21. Taj Loto - Economy Cable Lockout with 2 meter Vinyl Coated Steel Cable without Loop (TL - ECL+2C WL) \_\_\_\_\_ 1 set.
22. Taj Loto - Cable Padlock of 2 Feet Vinly Coated Steel (TL - CP - 2VCSC) \_\_\_\_\_ 1 no.
23. Taj Loto - De-Electric - Premier Lockout Safety Padlock with 46mm Shackle Height - Key Different (TL - DE-PLSP 46- KD Red) \_\_\_\_\_ 2 nos.
24. Taj Loto - Jacket Padlock with Long Shackle - Same Key - Yellow Colour (TL - JPLS - SK) \_\_\_\_\_ 3 nos.
25. Taj Loto - Safety Lockout Tags (TL - TAGS) \_\_\_\_\_ 10 nos.
26. Taj Loto - Nylon Ties (TL - TIES) \_\_\_\_\_ 10 nos.
27. Taj Loto - Pen for Tags and Loto Labels (TL - PEN) \_\_\_\_\_ 1 no.
28. Taj Loto - Screwdriver for Circuit Breaker Lockout (TL - SD FCBL) \_\_\_\_\_ 1 no.
29. Taj Loto - Lockout Tagout Station-1 in Clear Front (TL-LTS-1 CF) \_\_\_\_\_ 1 no.
30. Taj Loto Booklet (TL - Booklet) \_\_\_\_\_ 1 no.

## PREMIER LOCKOUT KIT - 07



Product code : TL - PL Kit - 07

1. Taj Loto - Electric - Flexible Lockout Hasp - 3 Hole, 3mm Shackle  
(TL - E - FLH 33) \_\_\_\_\_ 1 no.
2. Taj Loto - Electric - Flexible Lockout Hasp - 3 Hole, 6mm Shackle  
(TL - E - FLH 36) \_\_\_\_\_ 1 no.
3. Taj Loto - Electric - Flexible Lockout Hasp - 6 Hole, 6mm Shackle  
(TL - E - FLH 66) \_\_\_\_\_ 1 no.
4. Taj Loto - Electric - Flexible Lockout Hasp - 6 Hole, 5mm Shackle  
(TL - E - FLH 65) \_\_\_\_\_ 1 no.
5. Taj Loto - 1 Piece each of Pin In, Pin Out, Pin Out Wide Standard  
CBL (TL - COMBO CBL - 3) \_\_\_\_\_ 1 set.
6. Taj Loto - TIE BAR Standard Circuit Breaker Lockout  
(TL - TIE BAR CBL) \_\_\_\_\_ 1 no.
7. Taj Loto - Premier Lockout Safety Padlock with 46mm Shackle  
Height - Key Different - Red Colour (TL - PLSP 46 - KD) \_\_\_\_\_ 4 no.
8. Taj Loto - Small Plug Lockout - Premier (TL - SPLO - P) \_\_\_\_\_ 1 no.
9. TajLoto - Clamp-on Breaker Lockout - Small (TL - COBL - S) \_\_\_\_\_ 1 no.
10. TajLoto - Cleat for Small Clamp-on Breaker Lockout  
(TL - C / COBL - S) \_\_\_\_\_ 1 no.
12. TajLoto - Clamp-on Breaker Lockout - Medium (TL - COBL - M) \_\_\_\_\_ 1 no.
13. TajLoto - Cleat for Medium Clamp-on Breaker Lockout  
(TL - C / COBL - M) \_\_\_\_\_ 1 no.
14. TajLoto - Tight Grip Circuit Breaker Lockout Small (TL - TG CBL - S) \_\_\_\_\_ 1 no.
15. TajLoto - Tight Grip Circuit Breaker Lockout Large (TL - TG CBL - L) \_\_\_\_\_ 1 no.
16. Taj Loto - Safety Lockout Tags (TL - TAGS) \_\_\_\_\_ 5 no.
17. Taj Loto - Nylon Ties (TL - TIES) \_\_\_\_\_ 5 no.
18. Taj Loto - Pen for Tags and Loto Labels (TL - PEN) \_\_\_\_\_ 1 no.
19. Taj Loto - Lockout Box - 14 (TL - LP - 14) \_\_\_\_\_ 1 no.
20. Taj Loto Booklet (TL - Booklet) \_\_\_\_\_ 1 no.

## PREMIER LOCKOUT KIT - 08



Product code : TL - PL Kit - 09

1. Taj Loto - PVC Coated Hasp - Small (TL - PCH - S) \_\_\_\_\_ 2 no.
2. Taj Loto - PVC Coated Hasp - Premier (TL - PCH - P) \_\_\_\_\_ 2 no.
3. Taj Loto - Red Powder Coated Scorpio Hasp (TL - RPC SCORPIO) \_\_\_\_\_ 1 no.
4. Taj Loto - Electric - Flexible Lockout Hasp - 6 Hole, 6mm Shackle  
(TL - E - FLH 66) \_\_\_\_\_ 2 no.
5. Taj Loto - Electric - Flexible Lockout Hasp - 6 Hole, 5mm Shackle  
(TL - E - FLH 65) \_\_\_\_\_ 2 no.
6. Taj Loto - 1 Piece each of Pin In, Pin Out, Pin Out Wide Standard  
CBL (TL - COMBO CBL - 3) \_\_\_\_\_ 1 set.
7. Taj Loto - TIE BAR Standard Circuit Breaker Lockout  
(TL - TIE BAR CBL) \_\_\_\_\_ 1 set.
8. TajLoto - Tool Free Circuit Breaker Lockout (TL - TF CBL) \_\_\_\_\_ 1 no.
9. TajLoto - Tool Free Universal Circuit Breaker Lockout (TL - TF UCBL) \_\_\_\_\_ 1 no.
10. Taj Loto - Grip Type - Cable Lockout with 2mtrs. Vinyl Coated Steel Cable  
(TL - GTCL + 2C) \_\_\_\_\_ 1 no.
11. Taj Loto - Premier Lockout Safety Padlock with 46mm Shackle  
Height - Key Different + + Master Key - Red Colour (TL - PLSP 46 - KD+M) 1 set.
12. Taj Loto - Small Plug Lockout - Premier (TL - SPLO - P) \_\_\_\_\_ 1 no.
13. Taj Loto - Gate Valve Lockout - 2 (TL - GVL - 2). \_\_\_\_\_ 1 no.
14. TajLoto - Clamp-on Breaker Lockout - Small (TL - COBL - S) \_\_\_\_\_ 2 no.
15. TajLoto - Cleat for Small Clamp-on Breaker Lockout  
(TL - C / COBL - S) \_\_\_\_\_ 2 no.
16. TajLoto - Clamp-on Breaker Lockout - Medium (TL - COBL - M) \_\_\_\_\_ 2 no.
17. TajLoto - Cleat for Medium Clamp-on Breaker Lockout  
(TL - C / COBL - M) \_\_\_\_\_ 2 no.
18. TajLoto - Tight Grip Circuit Breaker Lockout Small (TL - TG CBL - S) \_\_\_\_\_ 2 no.
19. TajLoto - Tight Grip Circuit Breaker Lockout Large (TL - TG CBL - L) \_\_\_\_\_ 2 no.
20. Taj Loto - Safety Lockout Tags (TL - TAGS) \_\_\_\_\_ 10 no.
21. Taj Loto - Nylon Ties (TL - TIES) \_\_\_\_\_ 10 no.
22. Taj Loto - Pen for Tags and Loto Labels (TL - PEN) \_\_\_\_\_ 1 no.
23. Taj Loto - Lockout Box - 18 (TL - LP - 18) \_\_\_\_\_ 1 no.
24. Taj Loto Booklet (TL - Booklet) \_\_\_\_\_ 1 no.

## VALVE LOCKOUT KIT - 01



Product code : TL - VL Kit - 01

1. Taj Loto - Gate Valve Lockout - 2 (TL - GVL - 2) \_\_\_\_\_ 1 no.
2. Taj Loto - Gate Valve Adjustable Lockout (TL - GVAL) \_\_\_\_\_ 1 no.
3. Taj Loto - Gate Valve Lockout - 8 (TL - GVL - 8) \_\_\_\_\_ 1 no.
4. Taj Loto - Gate Valve Lockout - 10 (TL - GVL - 10) \_\_\_\_\_ 1 no.
5. Taj Loto - Ball Valve Lockout- 1 Extended in Side Locking Provision (TL - BVL-1 EX) \_\_\_\_\_ 1 no.
6. Taj Loto - Ball Valve Lockout- 4 Large in Side Locking Provision (TL - BVL-4 L) \_\_\_\_\_ 1 no.
7. Taj Loto - Butterfly Valve Lockout (TL - BFVL) \_\_\_\_\_ 1 no.
8. Taj Loto - Small Size Settable Ball Valve Lockout - with Small Arm (TL - SSBVL - SET (Small)) \_\_\_\_\_ 1 set.
9. Taj Loto - Small Arm with 4.5" inch SS Rod (TL - Small - Arm) \_\_\_\_\_ 1 no.
10. Taj Loto - Large Size Settable Ball Valve Lockout - with Large Arm (TL - LSBVL - SET (Large)) \_\_\_\_\_ 1 set.
11. Taj Loto - Large Arm with 5.75" inch SS Rod (TL - Large - Arm) \_\_\_\_\_ 1 no.
12. Taj Loto - Metallic Multipurpose Cable Lockout with 2 meter Stainless Steel Cable (TL - MMCL + 2 SSC) \_\_\_\_\_ 2 Sets.
13. Taj Loto - Universal Butterfly Valve with Gun Type Cable Lockout & 2 meters vinyl coated steel cable (TL- UBFVL+ GTCL+2C) \_\_\_\_\_ 1 Set.
14. Taj Loto - Universal Cable Lockout with 2 meter 4mm PVC coated steel cable (TL - UCL + 2C) \_\_\_\_\_ 1 Set.
15. Taj Loto - Small Plug Cover Lockout - Red (TL - SPCL - R) \_\_\_\_\_ 1 no.
16. Taj Loto - PVC Coated Hasp - Small (TL - PCH - S) \_\_\_\_\_ 2 nos.
17. Taj Loto - PVC Coated Hasp - Premier (TL - PCH - P) \_\_\_\_\_ 2 nos.
18. Taj Loto - Red Powder Coated Scorpio Hasp (TL- RPC SCORPIO) - \_\_\_\_\_ 1 no.
19. Taj Loto - Tago Hasp Red Colour (TL - TAGO RED) \_\_\_\_\_ 1 no.
20. Taj Loto - Jacket Padlock with Long Shackle - Key Different- Red & Yellow Colour (TL - JPLS - KD) \_\_\_\_\_ 6 nos.
21. Taj Loto - Safety Lockout Tags (TL - TAGS) \_\_\_\_\_ 20 nos.
22. Taj Loto - Nylon Ties (TL - TIES) \_\_\_\_\_ 20 nos.
23. Taj Loto - Pen for Tags and Loto Labels (TL - PEN) \_\_\_\_\_ 1 no.
24. Taj Loto - Lockout Bag Red & Yellow - Large (TL - LB R&Y - L) \_\_\_\_\_ 1 no.
25. Taj Loto Booklet (TL - Booklet) \_\_\_\_\_ 1 no.

## VALVE LOCKOUT KIT - 02



Product code : TL - VL Kit - 02

1. Taj Loto - Gate Valve Lockout - 2 (TL - GVL - 2) \_\_\_\_\_ 1 no.
2. Taj Loto - Gate Valve Lockout - 8 (TL - GVL - 4) \_\_\_\_\_ 1 no.
3. Taj Loto - Gate Valve Lockout - 6 (TL - GVL - 6) \_\_\_\_\_ 1 no.
4. Taj Loto - Ball Valve Lockout - 1 (TL - BVL-1) \_\_\_\_\_ 1 no.
5. Taj Loto - Ball Valve Lockout-1 Extended in Side Locking Provision (TL - BVL-1 EX) \_\_\_\_\_ 1 no.
6. Taj Loto - Butterfly Valve Lockout (TL - BFVL) \_\_\_\_\_ 1 no.
7. Taj Loto - Small Size Settable Ball Valve Lockout- with Small Arm (TL - SSBVL - SET (Small)) \_\_\_\_\_ 1 no.
8. Taj Loto - Small Arm with 4.5" SS Rod (TL - Small - Arm) \_\_\_\_\_ 1 no.
9. Taj Loto - Universal Cable Lockout with 2meter, 4mm thick PVC Coated Steel Cable (TL - UCL + 2C) \_\_\_\_\_ 1 set.
10. Taj Loto - PVC Coated Hasp - Small (TL - PCH - S) \_\_\_\_\_ 2 nos.
11. Taj Loto - PVC Coated Hasp - Premier (TL - PCH - P) \_\_\_\_\_ 2 nos.
12. Taj Loto - Red Powder Coated Scorpio Hasp (TL-RPC SCORPIO) - \_\_\_\_\_ 1 no.
13. Taj Loto - Jacket Padlock Long Shackle - Key Different - Set of 3, Red & Yellow & Blue colours (TL - JPLS - KD) \_\_\_\_\_ 1 set.
14. Taj Loto - Jacket Padlock Regular Shackle - Key Different - Set of 3, Red & Yellow & Blue colours (TL - JPRS - KD) \_\_\_\_\_ 1 set.
15. Taj Loto - Safety Lockout Tags (TL - TAGS) \_\_\_\_\_ 20 nos.
16. Taj Loto - Nylon Ties (TL - TIES) \_\_\_\_\_ 20 nos.
17. Taj Loto - Pen for Tags and Loto Labels (TL - PEN) \_\_\_\_\_ 1 no.
18. Taj Loto - Lockout Bag Red & Yellow - Medium (TL - LB R&Y - M) - \_\_\_\_\_ 1 no.
19. Taj Loto Booklet (TL - Booklet) \_\_\_\_\_ 1 no.

## VALVE LOCKOUT KIT - 03



Product code : TL - VL Kit - 03

1. Taj Loto - Gate Valve Lockout - 2 (TL - GVL - 2) \_\_\_\_\_ 1 no.
2. Taj Loto - Gate Valve Lockout - 8 (TL - GVL - 4) \_\_\_\_\_ 1 no.
3. Taj Loto - Gate Valve Lockout - 6 (TL - GVL - 6) \_\_\_\_\_ 1 no.
4. Taj Loto - Ball Valve Lockout - 1 (TL - BVL-1) \_\_\_\_\_ 1 no.
5. Taj Loto - Ball Valve Lockout-1 Extended in Side Locking Provision (TL - BVL-1 EX) \_\_\_\_\_ 1 no.
6. Taj Loto - Butterfly Valve Lockout (TL - BFVL) \_\_\_\_\_ 1 no.
7. Taj Loto - Small Size Settable Ball Valve Lockout- with Small Arm (TL - SSBVL - SET (Small)) \_\_\_\_\_ 1 no.
8. Taj Loto - Small Arm with 4.5" SS Rod (TL - Small - Arm) \_\_\_\_\_ 1 no.
9. Taj Loto - Universal Cable Lockout with 2 meter, 4mm Thick PVC Coated Steel Cable (TL - UCL + 2C) \_\_\_\_\_ 1 set.
10. Taj Loto - Squeezer Cable Lockout with 1meter Metallic Blue Cable (TL - SCL - MB) \_\_\_\_\_ 1 no.
11. Taj Loto - PVC Coated Hasp - Small (TL - PCH - S) \_\_\_\_\_ 2 nos.
12. Taj Loto - PVC Coated Hasp - Premier (TL - PCH - P) \_\_\_\_\_ 2 nos.
13. Taj Loto - Red Powder Coated Scorpio Hasp (TL-RPC SCORPIO) \_\_\_\_\_ 1 no.
14. Taj Loto - Jacket Padlock Long Shackle - Key Different - Set of 3, Red & Yellow & Blue colours (TL - JPLS - KD) \_\_\_\_\_ 1 set.
15. Taj Loto - Jacket Padlock Regular Shackle - Key Different - Set of 3, Red & Yellow & Blue colours (TL - JPRS - KD) \_\_\_\_\_ 1 set.
16. Taj Loto - Safety Lockout Tags (TL - TAGS) \_\_\_\_\_ 20 nos.
17. Taj Loto - Nylon Ties (TL - TIES) \_\_\_\_\_ 20 nos.
18. Taj Loto - Pen for Tags and Loto Labels (TL - PEN) \_\_\_\_\_ 1 no.
19. Taj Loto - Lockout Tagout Station-1 in Clear Front (TL-LTS-1 CF) \_\_\_\_\_ 1 no.
20. Taj Loto Booklet (TL - Booklet) \_\_\_\_\_ 1 no.

## VALVE LOCKOUT KIT - 04



Product code : TL - VL Kit - 04

1. Taj Loto - Gate Valve Lockout - 2 (TL - GVL - 2) \_\_\_\_\_ 1 no.
2. Taj Loto - Gate Valve Adjustable Lockout (TL - GVAL) \_\_\_\_\_ 1 no.
3. Taj Loto - Gate Valve Lockout - 8 (TL - GVL - 8) \_\_\_\_\_ 1 no.
4. Taj Loto - Gate Valve Lockout - 10 (TL - GVL - 10) \_\_\_\_\_ 1 no.
5. Taj Loto - Ball Valve Lockout- 1 Extended in Side Locking Provision (TL - BVL-1 EX) \_\_\_\_\_ 1 no.
6. Taj Loto - Ball Valve Lockout- 4 Large in Side Locking Provision (TL - BVL-4 L) \_\_\_\_\_ 1 no.
7. Taj Loto - Butterfly Valve Lockout (TL - BFVL) \_\_\_\_\_ 1 no.
8. Taj Loto - Small Size Settable Ball Valve Lockout - with Small Arm (TL - SSBVL - SET (Small)) \_\_\_\_\_ 1 set.
9. Taj Loto - Small Arm with 4.5" inch SS Rod (TL - Small - Arm) \_\_\_\_\_ 1 no.
10. Taj Loto - Large Size Settable Ball Valve Lockout - with Large Arm (TL - LSBVL - SET (Large)) \_\_\_\_\_ 1 set.
11. Taj Loto - Large Arm with 5.75" inch SS Rod (TL - Large - Arm) \_\_\_\_\_ 1 no.
12. Taj Loto - Metallic Multipurpose Cable Lockout with 2 meters Stainless Steel Cable (TL - MMCL + 2 SSC) \_\_\_\_\_ 2 Sets.
13. Taj Loto - Universal Butterfly Valve with Gun Type Cable Lockout & 2 meters vinyl coated steel cable (TL- UBFVL+ GTCL+2C) \_\_\_\_\_ 1 Set.
14. Taj Loto - Universal Cable Lockout with 2meter, 4mm thick PVC coated steel cable (TL - UCL + 2C) \_\_\_\_\_ 1 Set.
15. Taj Loto - Small Plug Cover Lockout - Red (TL - SPCL - R) \_\_\_\_\_ 1 no.
16. Taj Loto - PVC Coated Hasp - Small (TL - PCH - S) \_\_\_\_\_ 2 nos.
17. Taj Loto - PVC Coated Hasp - Premier (TL - PCH - P) \_\_\_\_\_ 2 nos.
18. Taj Loto - Red Powder Coated Scorpio Hasp (TL- RPC SCORPIO) \_\_\_\_\_ 1 no.
19. Taj Loto - Tago Hasp Red Colour (TL - TAGO RED) \_\_\_\_\_ 1 no.
20. Taj Loto - Jacket Padlock with Long Shackle - Key Different- Red & Yellow Colour (TL - JPLS - KD) \_\_\_\_\_ 6 nos.
21. Taj Loto - Safety Lockout Tags (TL - TAGS) \_\_\_\_\_ 20 nos.
22. Taj Loto - Nylon Ties (TL - TIES) \_\_\_\_\_ 20 nos.
23. Taj Loto - Pen for Tags and Loto Labels (TL - PEN) \_\_\_\_\_ 1 no.
24. Taj Loto - Lockout Tagout Station-2, Clear Front (TL- LTS-2 CF) \_\_\_\_\_ 1 no.
25. Taj Loto Booklet (TL - Booklet) \_\_\_\_\_ 1 no.

## ELECTRICAL & VALVE LOCKOUT KIT - 01



Product code : TL - EVL Kit - 01

1. Taj Loto - Combo Circuit Breaker Lockout (Set of 5) 1 piece of each TL-MCBL-Y, TL-MCBL-GS, TL-UMCBL-B, TL-UMCBL-GT and TL-UBCBL (TL - COMBO Set of 5) \_\_\_\_\_ 1 Set.
2. Taj Loto - 1 Piece each of Pin In, Pin Out, Pin Out Wide Standard CBL (TL - COMBO CBL - 3) \_\_\_\_\_ 1 Set.
3. Taj Loto - TIE BAR Standard CBL (TL - TIE BAR CBL) \_\_\_\_\_ 1 no.
4. Taj Loto - Universal Circuit Breaker Lockout - A (TL - UCBL - A) \_\_\_\_\_ 1 no.
5. Taj Loto - Universal Circuit Breaker Lockout - B (TL - UCBL - B) \_\_\_\_\_ 1 no.
6. Taj Loto - Large CBL with Round Handle (TL - LCB - R) \_\_\_\_\_ 1 no.
7. Taj Loto - Small Plug Lockout - Premier (TL - SPLO - P) \_\_\_\_\_ 1 no.
8. Taj Loto - Large Plug Lockout - Premier (TL - LPLO - P) \_\_\_\_\_ 1 no.
9. Taj Loto - Cylinder Electrical - Plug Lockout (TL - CE - PL) \_\_\_\_\_ 1 no.
10. Taj Loto - Squeezer Cable Lockout with De-Electric - Yellow Cable, Supplied with 1mtr. cable (TL - SCL - DE - Y) \_\_\_\_\_ 1 no.
11. Taj Loto - Electric - Flexible Lockout Hasp - 3 Hole, 3mm Shackle (TL - E - FLH 33) \_\_\_\_\_ 1 no.
12. Taj Loto - Electric - Flexible Lockout Hasp - 3 Hole, 6mm Shackle (TL - E - FLH 36) \_\_\_\_\_ 1 no.
13. Taj Loto - Electric - Flexible Lockout Hasp - 6 Hole, 6mm Shackle (TL - E - FLH 66) \_\_\_\_\_ 1 no.
14. Taj Loto - Gate Valve Adjustable Lockout (TL - GVAL) \_\_\_\_\_ 1 no.
15. Taj Loto - Ball Valve Lockout- 1 Extended in Side Locking Provision (TL - BVL-1 EX) \_\_\_\_\_ 1 no.
16. Taj Loto - Butterfly Valve Lockout (TL - BFVL) \_\_\_\_\_ 1 no.
17. Taj Loto - Small Size Settable Ball Valve Lockout with Small Arm (TL - SSBVL - SET (Small)) \_\_\_\_\_ 1 no.
18. Taj Loto - Small Arm with 4.5" inch SS Rod (TL - Small - Arm) \_\_\_\_\_ 1 no.
19. Taj Loto - Large Size Settable Ball Valve Lockout with Large Arm (TL - LSBVL - SET (Large)) \_\_\_\_\_ 1 no.
20. Taj Loto - Large Arm with 5.75" inch SS Rod (TL - Large - Arm) \_\_\_\_\_ 1 no.
21. Taj Loto - Metallic Multipurpose Cable Lockout with 2 meters Stainless Steel Cable (TL - MMCL + 2 SSC) \_\_\_\_\_ 1 Set.
22. Taj Loto - Premier Cable Lockout with 2 meter Vinyl Coated Steel Cable with Loop (TL - PCL+2C L) \_\_\_\_\_ 1 Set.
23. Taj Loto - Squeezer Cable Lockout with Metallic Blue Cable, Supplied with 1 meter cable (TL - SCL - MB) \_\_\_\_\_ 1 no.
24. Taj Loto - Large Plug Cover Lockout - Red (TL - LPCL - R) \_\_\_\_\_ 1 no.
25. Taj Loto - PVC Coated Hasp - Small (TL - PCH - S) \_\_\_\_\_ 1 no.
26. Taj Loto - PVC Coated Hasp - Premier (TL - PCH - P) \_\_\_\_\_ 1 no.
27. Taj Loto - Red Powder Coated Scorpio Hasp (TL - RPC SCORPIO) \_\_\_\_\_ 2 nos.
28. Taj Loto - Tago Hasp Red Colour (TL - TAGO RED) \_\_\_\_\_ 1 no.
29. Taj Loto - De-Electric - Premier Lockout Safety Padlock with 46mm Shackle Height - Key Different (TL - DE-PLSP 46-KD RED) \_\_\_\_\_ 3 nos.
30. Taj Loto - Jacket Padlock with Regular Shackle - Key Different- Yellow Colour (TL - JPRS - KD) \_\_\_\_\_ 3 nos.
31. Taj Loto - Jacket Padlock with Long Shackle - Key Different- Blue Colour (TL - JPLS - KD) \_\_\_\_\_ 3 nos.
32. Taj Loto - Safety Lockout Tags (TL - TAGS) \_\_\_\_\_ 20 nos.
33. Taj Loto - Nylon Ties (TL - TIES) \_\_\_\_\_ 20 nos.
34. Taj Loto - Pen for Tags and Loto Labels (TL - PEN) \_\_\_\_\_ 1 no.
35. Taj Loto - Screwdriver for CBL (TL - SD FCBL) \_\_\_\_\_ 1 no.
36. Taj Loto - Lockout Bag Red & Yellow - Medium (TL - LB R&Y - M) \_\_\_\_\_ 1 no.
37. Taj Loto Booklet (TL - Booklet) \_\_\_\_\_ 1 no.

## ELECTRICAL & VALVE LOCKOUT KIT - 02



Product code : **LT - EVL Kit - 02**

1. Taj Loto - Combo Circuit Breaker Lockout (Set of 5) 1 piece of each TL-MCBL-Y, TL-MCBL-GS, TL-UMCBL-B, TL-UMCBL-GT and TL-UBCBL (TL - COMBO Set of 5) \_\_\_\_\_ 1 Set.
2. Taj Loto - 1 Piece each of Pin In, Pin Out, Pin Out Wide Standard CBL (TL - COMBO CBL - 3) \_\_\_\_\_ 1 Set.
3. Taj Loto - TIE BAR Standard CBL (TL - TIE BAR CBL) \_\_\_\_\_ 1 no.
4. Taj Loto - Universal Circuit Breaker Lockout - A (TL - UCBL - A) \_\_\_\_\_ 1 no.
5. Taj Loto - Universal Circuit Breaker Lockout - B (TL - UCBL - B) \_\_\_\_\_ 1 no.
6. Taj Loto - Large CBL with Round Handle (TL - LCB - R) \_\_\_\_\_ 1 no.
7. Taj Loto - Small Plug Lockout - Premier (TL - SPLO - P) \_\_\_\_\_ 1 no.
8. Taj Loto - Large Plug Lockout - Premier (TL - LPLO - P) \_\_\_\_\_ 1 no.
9. Taj Loto - Cylinder Electrical - Plug Lockout (TL - CE - PL) \_\_\_\_\_ 1 no.
10. Taj Loto - Squeezer Cable Lockout with De-Electric - Yellow Cable, Supplied with 1mtr. cable (TL - SCL - DE - Y) \_\_\_\_\_ 1 no.
11. Taj Loto - Electric - Flexible Lockout Hasp - 3 Hole, 3mm Shackle (TL - E - FLH 33) \_\_\_\_\_ 1 no.
12. Taj Loto - Electric - Flexible Lockout Hasp - 3 Hole, 6mm Shackle (TL - E - FLH 36) \_\_\_\_\_ 1 no.
13. Taj Loto - Electric - Flexible Lockout Hasp - 6 Hole, 6mm Shackle (TL - E - FLH 66) \_\_\_\_\_ 1 no.
14. Taj Loto - Electric - Flexible Lockout Hasp - 6 Hole, 5mm Shackle (TL - E - FLH 65) \_\_\_\_\_ 1 no.
15. Taj Loto - Gate Valve Adjustable Lockout (TL - GVAL) \_\_\_\_\_ 1 no.
16. Taj Loto - Ball Valve Lockout- 1 Extended in Side Locking Provision (TL - BVL-1 EX) \_\_\_\_\_ 1 no.
17. Taj Loto - Butterfly Valve Lockout (TL - BFVL) \_\_\_\_\_ 1 no.
18. Taj Loto - Small Size Settable Ball Valve Lockout with Small Arm (TL - SSBVL - SET (Small)) \_\_\_\_\_ 1 no.
19. Taj Loto - Small Arm with 4.5" inch SS Rod (TL - Small - Arm) \_\_\_\_\_ 1 no.
20. Taj Loto - Large Size Settable Ball Valve Lockout with Large Arm (TL - LSBVL - SET (Large)) \_\_\_\_\_ 1 no.
21. Taj Loto - Large Arm with 5.75" inch SS Rod (TL - Large - Arm) \_\_\_\_\_ 1 Set.
22. Taj Loto - Metallic Multipurpose Cable Lockout with 2mtrs. Stainless Steel Cable (TL - MMCL + 2 SSC) \_\_\_\_\_ 1 Set.
23. Taj Loto - Premier Cable Lockout with 2 meter Vinyl Coated Steel Cable with Loop (TL - PCL+2C L) \_\_\_\_\_ 1 no.
24. Taj Loto - Squeezer Cable Lockout with Metallic Blue Cable, Supplied with 1 meter cable (TL - SCL - MB) \_\_\_\_\_ 1 no.
25. Taj Loto - Large Plug Cover Lockout - Red (TL - LPCL - R) \_\_\_\_\_ 1 no.
26. Taj Loto - PVC Coated Hasp - Small (TL - PCH - S) \_\_\_\_\_ 1 no.
27. Taj Loto - PVC Coated Hasp - Premier (TL - PCH - P) \_\_\_\_\_ 2 nos.
28. Taj Loto - Red Powder Coated Scorpio Hasp (TL - RPC SCORPIO) \_\_\_\_\_ 1 no.
29. Taj Loto - Tago Hasp Red Colour (TL - TAGO RED) \_\_\_\_\_ 1 no.
30. Taj Loto - De-Electric - Premier Lockout Safety Padlock with 46mm Shackle Height - Key Different (TL - DE-PLSP 46-KD RED) \_\_\_\_\_ 3 nos.
31. Taj Loto - Jacket Padlock with Regular Shackle - Key Different- Yellow Colour (TL - JPRS - KD) \_\_\_\_\_ 3 nos.
32. Taj Loto - Jacket Padlock with Long Shackle - Key Different- Blue Colour (TL - JPLS - KD) \_\_\_\_\_ 3 nos.
33. Taj Loto - Safety Lockout Tags (TL - TAGS) \_\_\_\_\_ 20 nos.
34. Taj Loto - Nylon Ties (TL - TIES) \_\_\_\_\_ 20 nos.
35. Taj Loto - Pen for Tags and Loto Labels (TL - PEN) \_\_\_\_\_ 1 no.
36. Taj Loto - Screwdriver for CBL (TL - SD FCBL) \_\_\_\_\_ 1 no.
37. Taj Loto - Lockout Tagout Station-2 in Clear Front (TL - LTS-2 CF) \_\_\_\_\_ 1 no.
38. Taj Loto Booklet (TL - Booklet) \_\_\_\_\_ 1 no.

## CYLINDER & PNEUMATIC LOCKOUT KIT - 01



Product code : TL - TL - C&P L Kit - 01

1. Taj Loto - Cylinder Lockout - Full (TL - CL - Full) \_\_\_\_\_ 1 no.
2. Taj Loto - Cylinder Lockout - Empty (TL - CL - Empty) \_\_\_\_\_ 1 no.
3. Taj Loto - Pneumatic Lockout Straight with 9 Holes (TL- PL 9 H) \_\_\_\_\_ 1 no.
4. Taj Loto - Small Plug Lockout - Premier (TL - SPLO) \_\_\_\_\_ 1 no.
5. Taj Loto - Large Plug Lockout - Premier (TL - LPLO) \_\_\_\_\_ 1 no.
6. Taj Loto - Gate Valve - Cylinder Lockout (TL - GVCL) \_\_\_\_\_ 1 no.
7. Taj Loto - Premier Cable Lockout with 2 meters Vinyl Coated Steel Cable with Loop (TL - PCL+2C L) \_\_\_\_\_ 1 Set.
8. Taj Loto - Large Plug Cover Lockout - Red (TL - LPCL - R) \_\_\_\_\_ 1 no.
9. Taj Loto - PVC Coated Hasp - Small (TL - PCH - S) \_\_\_\_\_ 2 nos.
10. Taj Loto - PVC Coated Hasp - Premier (TL - PCH - P) \_\_\_\_\_ 2 nos.
11. Taj Loto - Red Powder Coated Scorpio Hasp (TL- RPC SCORPIO) \_\_\_\_\_ 1 no.
12. Taj Loto - Jacket Padlock with Regular Shackle - Key Different - Yellow Colour (TL - JPRS - KD) \_\_\_\_\_ 3 nos.
13. Taj Loto - Jacket Padlock with Long Shackle - Key Different - Red Colour (TL - JPLS - KD) \_\_\_\_\_ 3 nos.
14. Taj Loto - 3 Way Pneumatic Lockout (TL - 3W PnL) \_\_\_\_\_ 1 no.
15. Taj Loto - Safety Lockout Tags (TL - TAGS) \_\_\_\_\_ 10 nos.
16. Taj Loto - Nylon Ties (TL - TIES) \_\_\_\_\_ 10 nos.
17. Taj Loto - Pen for Tags and Loto Labels (TL - PEN) \_\_\_\_\_ 1 no.
18. Taj Loto - Lockout Bag Red & Yellow - Small (TL - LB R&Y - S) \_\_\_\_\_ 1 no.
19. Taj Loto Booklet (TL - Booklet) \_\_\_\_\_ 1 no.

## CYLINDER & PNEUMATIC LOCKOUT KIT - 02



Product code : TL - C&P L Kit - 02

1. Taj Loto - Cylinder Lockout - Full (TL - CL - Full) \_\_\_\_\_ 1 no.
2. Taj Loto - Cylinder Lockout - Empty (TL - CL - Empty) \_\_\_\_\_ 1 no.
3. Taj Loto - Pneumatic Lockout Straight with 9 Holes (TL- PL 9 H) \_\_\_\_\_ 1 no.
4. Taj Loto - Small Plug Lockout - Premier (TL - SPLO) \_\_\_\_\_ 1 no.
5. Taj Loto - Large Plug Lockout - Premier (TL - LPLO) \_\_\_\_\_ 1 no.
6. Taj Loto - Gate Valve - Cylinder Lockout (TL - GVCL) \_\_\_\_\_ 1 no.
7. Taj Loto - Squeezer Cable Lockout with 1meter Metallic Blue cable (TL - SCL - MB) \_\_\_\_\_ 1 Set.
8. Taj Loto - Large Plug Cover Lockout - Red (TL - LPCL - R) \_\_\_\_\_ 1 no.
9. Taj Loto - PVC Coated Hasp - Small (TL - PCH - S) \_\_\_\_\_ 2 nos.
10. Taj Loto - PVC Coated Hasp - Premier (TL - PCH - P) \_\_\_\_\_ 2 nos.
11. Taj Loto - Red Powder Coated Scorpio Hasp (TL- RPC SCORPIO) \_\_\_\_\_ 1 no.
12. Taj Loto - Jacket Padlock with Regular Shackle - Key Different - Yellow Colour (TL - JPRS - KD) \_\_\_\_\_ 3 nos.
13. Taj Loto - Jacket Padlock with Long Shackle - Key Different - Red Colour (TL - JPLS - KD) \_\_\_\_\_ 3 nos.
14. Taj Loto - 3 Way Pneumatic Lockout (TL - 3W PnL) \_\_\_\_\_ 1 no.
15. Taj Loto - Safety Lockout Tags (TL - TAGS) \_\_\_\_\_ 10 nos.
16. Taj Loto - Nylon Ties (TL - TIES) \_\_\_\_\_ 10 nos.
17. Taj Loto - Pen for Tags and Loto Labels (TL - PEN) \_\_\_\_\_ 1 no.
18. Taj Loto - Lockout Tagout Station-1 in Clear Front (TL- LTS-1 CF) \_\_\_\_\_ 1 no.
19. Taj Loto Booklet (TL - Booklet) \_\_\_\_\_ 1 no.

## CYLINDER LOCKOUT KIT - 01



Product code : TL - CL Kit - 01

- |   |         |
|---|---------|
| 1. Taj Loto - Cylinder Lockout - Full (TL - CL - Full)  | 1 no.   |
| 2. Taj Loto - Cylinder Lockout - Empty (TL - CL - Empty)  | 1 no.   |
| 3. Taj Loto - Cylinder Lockout - Complete Yellow (TL - CL - CY)   | 1 no.   |
| 4. Taj Loto - Valve Cylinder Lockout + Economy Cable Lockout with 5 meter Cable with Loop (TL - VCL + ECL-5C L)         | 1 no.   |
| 5. Taj Loto - Gate Valve - Cylinder Lockout (TL - GVCL)   | 1 no.   |
| 6. Taj Loto - Premier Cable Lockout with 2 meter Vinyl Coated Steel Cable with Loop (TL - PCL+2C L)                     | 1 set.  |
| 7. Taj Loto - PVC Coated Hasp - Small (TL - PCH - S)  | 2 nos.  |
| 8. Taj Loto - PVC Coated Hasp - Premier (TL - PCH - P)  | 2 nos.  |
| 9. Taj Loto - Red Powder Coated Scorpio Hasp (TL - RPC SCORPIO)   | 1 no.   |
| 10. Taj Loto - Premier Lockout Safety Padlock with 46mm Shackle Height - Key Different - Red Colour (TL - PLSP 46 - KD) | 2 nos.  |
| 11. Taj Loto - Jacket Padlock with Long Shackle - Key Different - Yellow Colour (TL - JPLS - KD)                        | 2 nos.  |
| 12. Taj Loto - Safety Lockout Tags (TL - TAGS)  | 10 nos. |
| 13. Taj Loto - Nylon Ties (TL - TIES)   | 10 nos. |
| 14. Taj Loto - Pen for Tags and Loto Labels (TL - PEN)  | 1 no.   |
| 15. Taj Loto - Lockout Bag Red & Yellow - Small (TL - LB R&Y - S)   | 1 no.   |
| 16. Taj Loto Booklet (TL - Booklet)   | 1 no.   |

## CYLINDER LOCKOUT KIT - 02



Product code : TL - CL Kit - 02

- |   |         |
|---|---------|
| 1. Taj Loto - Cylinder Lockout - Full (TL - CL - Full)  | 1 no.   |
| 2. Taj Loto - Cylinder Lockout - Empty (TL - CL - Empty)  | 1 no.   |
| 3. Taj Loto - Gate Valve Lockout - 2 (TL - GVL - 2)   | 1 no.   |
| 4. Taj Loto - Gate Valve Lockout - 4 (TL - GVL - 4)   | 1 no.   |
| 5. Taj Loto - Ball Valve Lockout-1 in Side Locking (TL - BVL-1)   | 1 no.   |
| 6. Taj Loto - PVC Coated Hasp - Small (TL - PCH - S)  | 1 no.   |
| 7. Taj Loto - PVC Coated Hasp - Premier (TL - PCH - P)  | 1 no.   |
| 8. Taj Loto - Red Powder Coated Scorpio Hasp (TL-RPC SCORPIO)   | 1 no.   |
| 9. Taj Loto - Electric - Flexible Lockout Hasp - 3 Hole, 3mm Shackle (TL - E - FLH 33)  | 1 no.   |
| 10. Taj Loto - Electric - Flexible Lockout Hasp - 3 Hole, 6mm Shackle (TL - E - FLH 36)   | 1 no.   |
| 11. Taj Loto - Electric - Flexible Lockout Hasp - 6 Hole, 6mm Shackle (TL - E - FLH 66)   | 1 no.   |
| 12. Taj Loto - Electric Flexible Lockout Hasp - 6 Hole, 5.5mm Shackle (TL - E - FLH 65)   | 1 no.   |
| 13. Taj Loto - Combo Circuit Breaker Lockout (Set of 5) 1 piece of each TL-MCBL-Y, TL-MCBL-GS, TL-UMCBL-B, TL-UMCBL-GT and TL-UBCBL (TL - COMBO Set of 5) | 1 set.  |
| 14. Taj Loto - 1 Piece each of Pin In, Pin Out, Pin Out Wide Standard CBL (TL - COMBO CBL - 3)  | 1 set.  |
| 15. Taj Loto - Universal Circuit Breaker Lockout - A (TL - UCBL - A)  | 1 no.   |
| 16. Taj Loto - Universal Circuit Breaker Lockout - B (TL - UCBL - B)  | 1 no.   |
| 17. Taj Loto - Large CBL with Round Handle (TL - LCB - R)   | 1 no.   |
| 18. Taj Loto - Small Plug Lockout - Premier (TL - SPLO - P)   | 1 no.   |
| 19. Taj Loto - Squeezer Cable Lockout with Metallic Blue Cable, Supplied with 1 meter cable (TL - SCL - MB)   | 1 no.   |
| 20. Taj Loto - Economy Cable Lockout with 2 meter Vinyl Coated Steel Cable without Loop (TL - ECL+2C WL)  | 1 set.  |
| 21. Taj Loto - De-Electric - Premier Lockout Safety Padlock with 46mm Shackle Height - Key Different (TL - DE-PLSP 46- KD Red)                            | 2 nos.  |
| 22. Taj Loto - Jacket Padlock with Long Shackle - Key Different- Yellow Colour (TL - JPLS - KD)   | 3 nos.  |
| 23. Taj Loto - Safety Lockout Tags (TL - TAGS)  | 10 nos. |
| 24. Taj Loto - Nylon Ties (TL - TIES)   | 10 nos. |
| 25. Taj Loto - Pen for Tags and Loto Labels (TL - PEN)  | 1 no.   |
| 26. Taj Loto - Lockout Box - 16 (TL - LB - 16)  | 1 no.   |
| 27. Taj Loto Booklet (TL - Booklet)   | 1 no.   |



## CABLE LOCKOUT KIT - 01



Product code : TL - CL Kit - 01

1. Taj Loto Premier Cable Lockout with 2 meters Vinyl Coated Steel Cable with Loop (TL - PCL+2C L) \_\_\_\_\_ 1 set.
2. Taj Loto - Squeezer Cable Lockout with Metallic Blue Cable, Supplied with 1 meter cable (TL - SCL - MB) \_\_\_\_\_ 1 no.
3. Taj Loto - Economy Cable Lockout with 2meters Vinyl Coated Steel Cable with Loop (TL - ECL+2C L) \_\_\_\_\_ 1 set.
4. Taj Loto - Grip Type - Cable Lockout with 2 meters Vinyl Coated Steel Cable (TL - GTCL + 2C) \_\_\_\_\_ 1 no.
5. Taj Loto - Metallic Multipurpose Cable Lockout with 2 meters Stainless Steel Cable (TL - MMCL + 2 SSC) \_\_\_\_\_ 1 set.
6. Taj Loto - Premier Lockout Safety Padlock with 46mm Shackle Height - Key Different - Red Colour (TL - PLSP 46 - KD) \_\_\_\_\_ 2 nos.
7. Taj Loto - Safety Lockout Tags (TL - TAGS) \_\_\_\_\_ 5 nos.
8. Taj Loto - Nylon Ties (TL - TIES) \_\_\_\_\_ 5 nos.
9. Taj Loto - Pen for Tags and Loto Labels (TL - PEN) \_\_\_\_\_ 1 no.
10. Taj Loto - Lockout Pouch - 01 Red (TL - LP - 01 Red) \_\_\_\_\_ 1 no.
11. Taj Loto Booklet (TL - Booklet) \_\_\_\_\_ 1 no.

## CABLE LOCKOUT KIT - 02



Product code : TL - CL Kit - 02

1. Taj Loto - Razor Look Cable Lockout with 2 meters Vinyl Coated Steel Cable with Loop (TL - RLCL + 2C L) \_\_\_\_\_ 1 set.
2. Taj Loto - Squeezer Cable Lockout with De-Electric - Yellow Cable, Supplied with 1 meter cable (TL - SCL - DE - Y) \_\_\_\_\_ 1 no.
3. Taj Loto - Universal Cable Lockout with 2 meters, 4mm Thick PVC Coated Steel Cable (TL - UCL + 2C) \_\_\_\_\_ 1 set.
4. Taj Loto - Economy Cable Lockout + Tool with 2 meters Vinyl Coated Steel Cable - with Loop (TL - ECL-T+2C L) \_\_\_\_\_ 1 set.
5. Taj Loto - Economy Metallic Cable Lockout with 2 meters Stainless Steel Cable (TL - EMCL+2SSC) \_\_\_\_\_ 1 no.
6. Taj Loto - 7 Hole Hasp Look Cable Lockout with 2 meters Vinyl Coated Steel Cable with Loop (TL - 7H HCL + 2C L) \_\_\_\_\_ 1 set.
7. Taj Loto - De-Electric - Premier Lockout Safety Padlock with 46mm Shackle Height - Key Different- Red (TL - DE-PLSP 46 - KD) \_\_\_\_\_ 2 nos.
8. Taj Loto - Premier Lockout Safety Padlock with 46mm Shackle Height - Key Different - Red colour (TL - PLSP 46 - KD) \_\_\_\_\_ 1 no.
9. Taj Loto - Safety Lockout Tags (TL - TAGS) \_\_\_\_\_ 10 nos.
10. Taj Loto - Nylon Ties (TL - TIES) \_\_\_\_\_ 10 nos.
11. Taj Loto - Pen for Tags and Loto Labels (TL - PEN) \_\_\_\_\_ 1 no.
12. Taj Loto - Lockout 3Pocket Belt Pouch - Red (TL - L3PBP - R) \_\_\_\_\_ 1 no.
13. Taj Loto Booklet (TL - Booklet) \_\_\_\_\_ 1 no.

## CABLE LOCKOUT KIT - 03



Product code : TL - CL Kit - 03

1. Taj Loto - Squeezer Cable Lockout with De-Electric - Yellow Cable, Supplied with 1 meter cable (TL - SCL - DE - Y) \_\_\_\_\_ 1 no.
2. Taj Loto - Economy Cable Lockout with 2meters Vinyl Coated Steel Cable without Loop (TL - ECL+2C WL) \_\_\_\_\_ 1 set.
3. Taj Loto - De-Electric - PLSP with 46mm Shackle Height - Key Different - Red Colour (TL - DE-PLSP 46 - KD) \_\_\_\_\_ 1 no.
4. Taj Loto - Premier Lockout Safety Padlock with 46mm Shackle Height - Key Different - Red Colour (TL - PLSP 46 - KD) \_\_\_\_\_ 1 no.
5. Taj Loto - Safety Lockout Tags (TL - TAGS) \_\_\_\_\_ 5 nos.
6. Taj Loto - Nylon Ties (TL - TIES) \_\_\_\_\_ 5 nos.
7. Taj Loto - Pen for Tags and Loto Labels (TL - PEN) \_\_\_\_\_ 1 no.
8. Taj Loto - Lockout Pouch - 03 Red (TL - LP - 03 Red) \_\_\_\_\_ 1 no.



All the kits can be customized as per your individual requirements and if ordered in volumes\* - Name of the Company / Logo / Department Name etc. can also be printed on these kits.

## CABLE LOCKOUT KIT - 04



1. Taj Loto - Squeezer Cable Lockout with Metallic Blue Cable,  
Supplied with 1 Meter Cable (TL - SCL - MB) \_\_\_\_\_ 1 no.
2. Taj Loto - Economy Cable Lockout with 2 Meters Vinyl Coated  
Steel Cable without Loop (TL - ECL+2C WL) \_\_\_\_\_ 1 Set.
3. Taj Loto - Premier Lockout Safety Padlock with 46mm Shackle  
Height - Key Different - Red Colour (TL - PLSP 46 - KD) \_\_\_\_\_ 2 no.
4. Taj Loto - Safety Lockout Tags (TL - TAGS) \_\_\_\_\_ 5 no.
5. Taj Loto - Nylon Ties (TL - TIES) \_\_\_\_\_ 5 no.
6. Taj Loto - Pen for Tags and Loto Labels (TL - PEN) \_\_\_\_\_ 1 no.
7. Taj Loto - Lockout Pouch - 05 Black (TL - LP - 05 B) \_\_\_\_\_ 1 no.

Product code : TL - CL Kit - 04



## SAFETY LOCKOUT TAGS

*Highly visible lockout safety tags aid the safe running and maintenance of site machinery.*

*Each Tag is made from high impact flexible polyvinyl sheets - resistant to water, oil and extreme temperatures, ensuring it will withstand a multitude of weather and factory conditions / harshest environments.*

*Their surface allows you to write on them easily with a marker pen (we also provide marker pens for tag).*

*All the Tags can be attached with a safety lockout devices directly or they can be attached with the help of a Nylon Tie.*

*Individual workers use the DANGER TAG while working on the equipments.*



DOMESTIC | [tajlotoindia@gmail.com](mailto:tajlotoindia@gmail.com)  
EXPORT | [tajlotoexport@gmail.com](mailto:tajlotoexport@gmail.com)

[tajlotosafety@gmail.com](mailto:tajlotosafety@gmail.com)  
[www.tajlotosafety.in](http://www.tajlotosafety.in)

## SAFETY LOCKOUT TAGS

- Highly visible **TAJ LOTO TAGS** aid the safe running and maintenance of site machinery.
- Each Tag is made from high impact flexible polyvinyl sheets - **resistant to water, oil and extreme temperatures, ensuring it will withstand a multitude of weather and factory conditions / harshest environments.**
- Their surface allows you to write on them easily with a marker pen (we also provide marker pens for tag).
- All the Tags can be attached with a safety lockout devices directly or they can be attached with the help of a Nylon Tie.
- Individual workers use the DANGER / WARNING TAG while working on the equipments.
- Make your own tag; customization accepted.
- Tags made from high quality screen printing on 0.5 & 0.7mm PVC sheet.
- Tag Size : 143 x 80 mm**, Safety lockout tags are available in pack 10 / 25 / 50 / 100.





TLT - 18



TLT - 19



TLT - 20

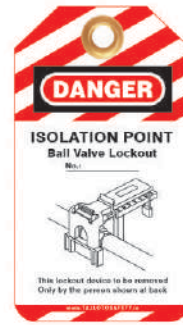

TLT - 21



TLT - 22



Common Back Side  
TLT - 18 to 22

## PROTECTIVE LINER TAGS (SELF LAMINATION)

- When you need a customized message that won't smudge or wear, use our TAJ LOTO self-laminating tags that let you seal in your message under a clear, protected layer.
- Simply remove the lining and press the clear polyester layer onto your text to laminate. Durable tags will resist water and wear in your facility.



TLT - 23 PL



TLT - 24 PL



TLT - 25



TLT - 26



TLT - 27



TLT - 28



TLT - 29



TLT - 30

## SAFETY LOCKOUT TAGS



TLT - 31



TLT - 32



TLT - 33



TLT - 34



TLT - 35



TLT - 36



TLT - 37



TLT - 38



TLT - 39



TLT - 40



TLT - 41

make your own tag  
in any language



## SAFETY LOCKOUT TAGS



TLT - 42



TLT - 43



TLT - 44



TLT - 45



TLT - 46



TLT - 47



TLT - 48

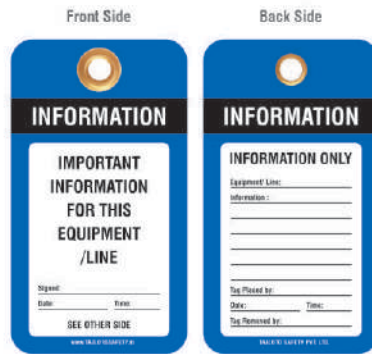

TLT - 49



TLT - 50



TLT - 51



TLT - 52

make your own tag  
in any language





## SAFETY LOCKOUT TAGS



TLT - Cust.- 4



TLT - Cust.- 5



TLT - Cust.- 6 (180 x 80 mm)



TLT - Cust.- 7 (175 x 80 mm)



TLT - Cust.- 8 (175 x 80 mm)

make your own tag  
in any language



TLT - Cust.- 9



TLT - Cust.- 10



TLT - Cust.- 11

Single Sided Tag

Other side blank

Tag Size:  
(175 x 80 mm)



TLT - Cust.- 12



TLT - Cust.- 13



TLT - Cust.- 14

## SAFETY LOCKOUT ECONOMY TAGS



TLT - ECO-1

Taj Loto Tag - Economy - 1

- ✦ **Made of hard paper** with high quality screen / offset printing. Ideal for short term indoor or outdoor isolations. Printed on both sides, each tag carries a standard message. (customization accepted).
- ✦ Economy (hard paper) tags are available in pack of 10 / 20 / 25 / 50 / 100 (\*Minium quantity applicable)
- ✦ **Tag Size : 143 x 80mm**



TLT - ECO-2

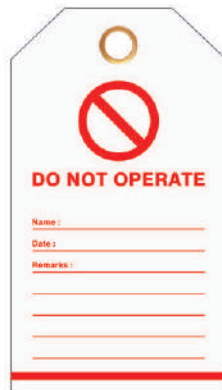

TLT - ECO-3



TLT - ECO-4



TLT - ECO-5



Common Front Side of  
TLT - ECO-2  
to  
TLT - ECO-9



TLT - ECO-6



TLT - ECO-7



TLT - ECO-8



TLT - ECO-9

## SAFETY LOCKOUT TAGS ON ROLL (BOX)

- 🏰 Convenient, Tough and Economical! Just "Pull" and "Tear" off a durable lockout tag from this handy roll.
- 🏰 A box makes it easy to keep your tags handy and neat.
- 🏰 Each tag size : 143 x 80 mm.
- 🏰 Tag is made of flexible plastic that is both tear-proof and waterproof.
- 🏰 Tags can be used inside or outdoors.
- 🏰 There are 100 tags in each box.



TLT - ROLL  
Taj Loto Tag - Roll  
**\*Minimum 10 Rolls**



## SAFETY LOCKOUT RHOMBUS TAG

These RHOMBUS TAGS are printed both sides with danger message and available in any colours.



Customized Rhombus tags in any colours\*



## PERFORATED (TAG+TAG) SAFETY LOCKOUT TAGS

- Two-part tags provide enhanced operational control and record-keeping. Stub is removed when tag is attached to a lockout point. Only the employee in possession of the stub has the authority to remove the tag.
- After the job is done, stub is returned to management for verification and monitoring of lockout and tagout activity in the plant.



**TL - PT+T1**  
Taj Loto - Perforated Tag + Tag-1  
Single Sided  
(Tag Size : 180 x 80mm)



make your own tag  
in any language



Rings can be  
ordered separately

## PROTECTIVE LINER SINGLE SIDED PHOTO LOCKOUT TAGS

- Tag made on 0.7 / 0.5 mm (as per customer requirement) on PVC sheet with Protective Liner (Self-laminating) tags allow employees to fill in vital information.
- Add a small size personal photo and seal it under the attached clear protective liner (self-adhesive overlay).
- Tag Size : 143 x 80 mm.



Protective Liner (Self Laminating)





TL - PL-SPT 1      TL - PL-SPT 2      TL - PL-SPT 3      TL - PL-SPT 4

Customization Accepted

Taj Loto - Protective Liner Single Sided Photo Tag

## SINGLE SIDED LOCKOUT SIGN-TAG

These single side sign-tag printed on 0.7 mm special grade PVC sheet. The Sign-Tag gives a clear caution message. Providing 10 pieces in 1 Set (minimum sets quantity applicable), Tag Size : 75 x 100 mm.

15mm eyelet, Inner hole size 9mm

Caution  
Persons working on equipment

Do not switch on

TL - SS S-T  
Taj Loto - Single Side Sign-Tag

## LOCKOUT PADLOCK JACKET TAGS

- Padlock jacket tags hang flat on padlock for quick identification ensuring that the status is noticed at a glance.
- These padlock tags are manufactured from 0.7mm PVC sheet.
- They are made as per customer's requirement with or without metal grommet that fits over most padlock shackles.



TL - PJT - 1

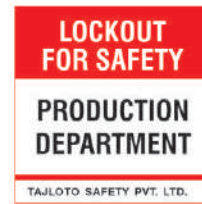

TL - PJT - 2

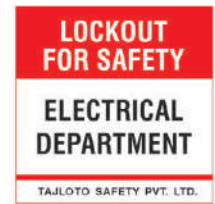

TL - PJT - 3



TL - PJT - 4



TL - PJT - 5



TL - PJT - 6



TL - PJT - 7



TL - PJT - 8



TL - PJT - 9

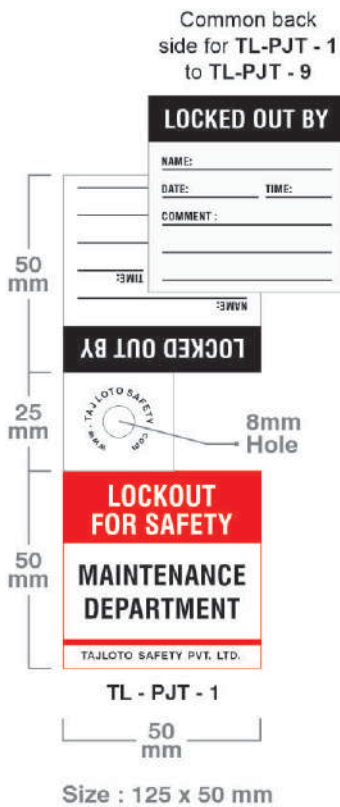

TL - PJT - 10



## SAFETY LOCKOUT STRIP TAGS

- ☛ Tag made of 0.5 mm superior grade PVC material for a greater resistance than paper to tear, chemical & humidity.
- ☛ Available in pack of 50 or 100 nos.
- ☛ Size of these padlock tags is 1" x 5" Inches.



**TL - STRIP TAG-SS**  
Taj Loto - Strip Tag - Single Sided

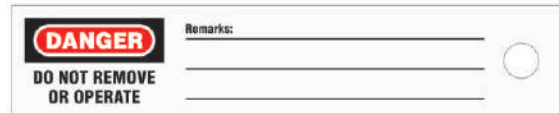

**TL - STRIP TAG-DS**  
Taj Loto - Strip Tag - Double Sided



## PEN for TAGS

- ☛ These special Waterproof, Lightfast, Multimark Pens are supplied for writing on the Tags. They contain eraser on the other end of the pen.
- ☛ Available in Black / Blue / Green & Red colours.

TL - PEN for Tags



## CABLE TIE FOR LOCKOUT TAGS

- Enables secure attachment of visual tagging system to equipment.
- Cable ties are made with a one piece construction to provide consistent performance and reliability.
- Available in set of 10 / 25 / 50 / 100 nos.
- 2 Sizes available in 6" and 8" Inch.



**TL - TIES-S**  
Taj Loto - Nylon Ties-Small  
in 6" inch for tags

**TL - TIES-B**  
Taj Loto - Nylon Ties-Big  
in 8" inch for tags

## ONE TIME USE LOCKOUT TAG-TIE SEAL

- TAG-TIE Lockout seal used for one time lockout.
- Can be supplied with vinyl non tearable self adhesive label with company details like logo / Tag no. / dept. name / location etc.
- Available in pack of 50 pieces and **Standard colour is WHITE & YELLOW.**
- Use hacksaw blade or cutter to remove this seal.



**TL - Tag-Tie - W**  
Taj Loto - One time use  
Tag-Tie in white colour



**TL - Tag-Tie - Y**  
Taj Loto - One time use  
Tag-Tie in yellow colour



## HOOK / POCKET TYPES TAGS STATION & HOLDER

- ☛ Your LOCKOUT / TAGOUT tags keep clean and organized with our Tag Station & Holder.
- ☛ **TajLoto - TS 8P & TL - TS 1P** is designed to hold 10 tags (with eyelet) and 20 Tags (without eyelet). You can hold maximum tag size of 143 x 80mm. Tag Station comes with screws & sleeves for mounting.
- ☛ **TajLoto - YB SLTS - 6HP** shadow tag station can be designed and supplied for various departments in a plant with company logo and other relevant information as desired / indicated in the company's lockout policy.
- ☛ Customized Tag Station can be made against order for any number of tag pockets / hooks.



**TL - TS - 8P WG / WOG**

Taj Loto - Tag Station - 8 Pocket, with / without goods  
(Insert 10 tags in each Pocket) Size : 17.5" x 17.5" inch



**TL - TH-4P WG / WOG**

TajLoto - Tag Holder - 4 Pocket  
with / without goods  
Size : 440 x 180 mm



**TL - TH-2P WG / WOG**

TajLoto - Tag Holder - 2 Pocket  
with / without goods  
Size : 220 x 180 mm



**TL - YB SLTS - 8HP WG / WOG**

Taj Loto - Yellow & Black, Shadow Lockout  
Tag Station - 8 Hook & 8 Pocket, with / without goods  
(Hang / insert 10 tags in each hook / pocket)  
Size : 30" x 18"



**TL - TS 1P WG / WOG**

Taj Loto - Tag Station, 1 Pocket, with / without goods  
(Size : 9" x 5" inch)





## ENERGY SOURCE IDENTIFICATION MINI TAGS

*With Energy Source Identification Tags, one can clearly identify the name and source of the energy source to be locked out.*



[tajlotosafety@gmail.com](mailto:tajlotosafety@gmail.com)

[www.tajlotosafety.in](http://www.tajlotosafety.in)

DOMESTIC | [tajlotoindia@gmail.com](mailto:tajlotoindia@gmail.com)

EXPORT | [tajlotoexport@gmail.com](mailto:tajlotoexport@gmail.com)

## ENERGY SOURCE IDENTIFICATION MINI TAGS

Energy sources carry a number of risks that affect workers who service machines and equipment. Assist workers in understanding hazardous energy sources by tagging them. These single sided printed Energy Source Identification mini Tag helps identify different control sources.

- These PVC 0.7 mm thick tags are tear-proof, weather-resistant, chemical-resistant and durable enough to withstand dirt, grease, liquid-splashes, repeated abuse, or rough handling.
- Order individual numbers as per requirement, or purchase a kit which includes numbers 1 - 10.
- Customized numbers can be ordered in the set of 10 nos.
- Mini Tag Size : 75 x 50mm



TL - ESID MT- 1



TL - ESID MT- 2



TL - ESID MT- 3



TL - ESID MT- 4

Taj Loto - Energy Source Identification Mini Tag



TL - ESID MT- 5



TL - ESID MT- 6



TL - ESID MT- 7



TL - ESID MT- 8



TL - ESID MT- 9



TL - ESID MT- 10



TL - ESID MT- 11



TL - ESID MT- 12

15mm brass eyelet,  
Hole size - 8mm



TL - ESID MT- 13



TL - ESID MT- 14



TL - ESID MT- 15



TL - ESID MT- 16

*Customization Accepted*

Ask for special prices for complete project



TL - ESID MT- 17



TL - ESID MT- 18

## ENERGY SOURCE IDENTIFICATION SELF STICK TAGS

⚠ These Identification tags are duly placed in the clear PVC casing with SS ring.

Tag Size : 57 x 100 mm

Case Size : 60 x 130 mm



TL - ESID SST + C  
Taj Loto - Energy Source  
Identification Self  
Stick Tag with Case

⚠ The Identification self stick vinyl tags are available without casing also, with the choice of different numbers (exp. E-1, E-2,...to more) as per customer requirement for directly fixing on the machine.

Self Stick Vinyl Tag Size : 48 x 90 mm



TL - ESID SST  
Taj Loto - Energy Source  
Identification Self Stick Tag



Ask for special prices  
for complete project



TL - ESID SST- 1



TL - ESID SST- 2



TL - ESID SST- 3



TL - ESID SST- 4



TL - ESID SST- 5



TL - ESID SST- 6



TL - ESID SST- 7



TL - ESID SST- 8



TL - ESID SST- 9



TL - ESID SST- 10



TL - ESID SST- 11



TL - ESID SST- 12



TL - ESID SST- 13



TL - ESID SST- 14



TL - ESID SST- 15



TL - ESID SST- 16



TL - ESID SST- 17



TL - ESID SST- 18



## SCAFFOLDING HOLDERS & TAGS / INSERTS

*This specially designed holder and insert system ensures that all the concerned people are well aware of the current status of the structure. A scaffold should be fitted at all ladder access points from the first build stage and is to remain on the structure until dismantled thereby communicating a safety message to all.*

*By adopting the scaffold, you are demonstrating your duty of care to your workers and that you have done everything reasonably practical to ensure safe access and egress from the place of work as well as giving them as much information required to work safely.*



DOMESTIC | [tajlotoindia@gmail.com](mailto:tajlotoindia@gmail.com)  
EXPORT | [tajlotoexport@gmail.com](mailto:tajlotoexport@gmail.com)

[tajlotosafety@gmail.com](mailto:tajlotosafety@gmail.com)  
[www.tajlotosafety.in](http://www.tajlotosafety.in)



# SCAFFOLDING HOLDER & TAGS / INSERTS



**TAJLOTO SAFETY PVT. LTD.**  
LOCKOUT TAGOUT MANUFACTURER

## SCAFFOLD / WIDE HOLDERS & INSERTS

☛ Printing on the Yellow / White Holders and inserts (tag) is done as per the requirements of the customer / site / process, etc.

☛ **Yellow / White tag holder kit contains; 10 holders, 20 inserts and 1 pen.**

Material : **Tag Holder** made of super grade ABS plastic and **inserts** made of 0.5mm thickness special grade PVC sheet.



**TL - WSH-Y**

Taj Loto - Wide Scaffolding Holder - Yellow colour  
(Holder Size : 325 x 155 x 6 mm)

**TL - WSH-W**

Taj Loto - Wide Scaffolding Holder - White colour



**TL - WHI-2**

Taj Loto - Wide Holder insert - 2

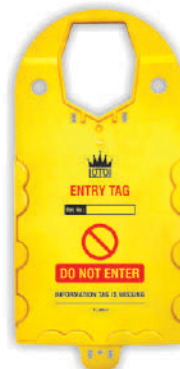

**TL - WHI-3**

Taj Loto - Wide Holder insert - 3



**TL - WHI-1**

Taj Loto - Wide Holder insert - 1  
(All wide insert size : 196 x 148 mm)



**TL - WHI-4**

Taj Loto - Wide Holder insert - 4

*Customization Accepted*



**TL - WHI-6**

Taj Loto - Wide Holder insert - 6

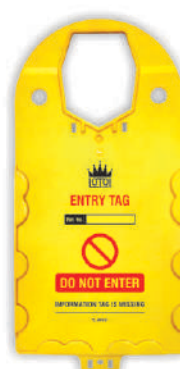

**TL - WHI-5**

Taj Loto - Wide Holder insert - 5

# SCAFFOLDING HOLDER & TAGS / INSERTS



**TAJLOTO SAFETY PVT. LTD.**  
LOCKOUT TAGOUT MANUFACTURER

## SCAFFOLDING ECONOMY TAGS

- ⚙️ Scaffolding economy tags are made on 0.7 mm white special grade PVC sheet with printed safety notifications.
- ⚙️ There is a die cut hole in the scaffolding tag, with the help of which we can place it on the scaffolding pipe.
- ⚙️ **Economy Tag kit contains; 50 Tags, 50 PVC cable Tie and 1 pen.**

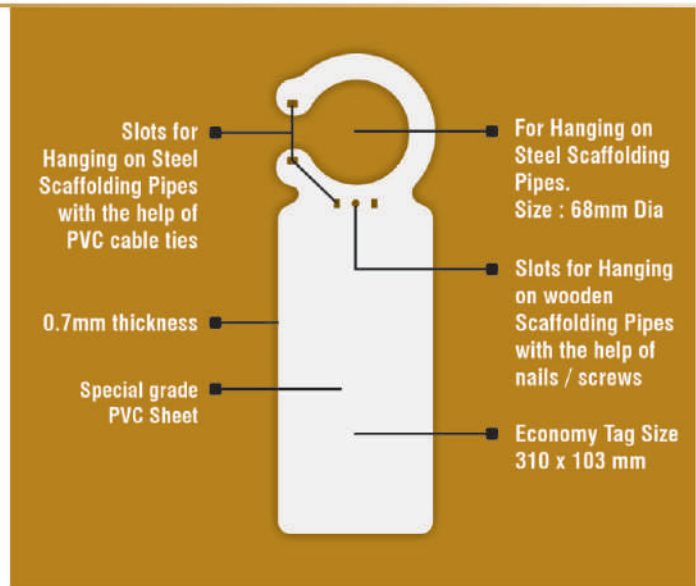

Taj Loto - Economy Scaffolding Tag



## SCAFFOLDING ECONOMY TAGS

**Customization Accepted**

We can make according to your Requirements.\*  
minimum quantity applicable



TL - ECO-ST-12



TL - ECO-ST-13



TL - ECO-ST-14

Economy Scaffolding tags are made on 0.7 mm re-writable white special grade PVC sheet with safety notifications, and are available in caution, danger or "OK" messages to indicate the state of scaffolding.

**Scaffold Tag kit contains; 50 Tags, 50 PVC cable Tie and 1 pen.**

All custom designs can be made and supplied as per the requirements of our customers.



TL - SFT-1



TL - SFT-2



TL - SFT-3

### Taj Loto - Scaffold Tag



TL - SFT-4



TL - SFT-5



TL - SFT-6



TL - SFT-7



TL - SFT-8



TL - SFT-9



## MINI ASSET MANAGEMENT HOLDER & INSERTS



**TL - MASH**  
Taj Loto  
Mini Asset Holder  
(Size : 92 x 41 x 6 mm)  
h x w x d

- Mini Asset Management Tag Holders are designed for areas where there is restricted space. They are great for use on cables, smaller machinery or on fall arrest equipment.
- Material : **Tag Holder** made of super grade ABS plastic and **inserts** made of 0.5mm special grade PVC sheet.
- With no insert in place the message 'Do not use this equipment' is displayed.
- Designed with the user in mind, all of our Tag Holders can be fixed using Cable Ties, Rivets, Adhesive Strips, Glue and the Mini Asset Tag Holders also have a hole suitable for a keyring or a split ring.
- Mini Asset / Property tag kit contains: 20 holders, 40 inserts, 1 pen, 20 cable ties or 1 double sided tape.

## Safe Working Load

### TL - i1-MASH

Taj Loto - insert 1 for Mini Asset Holder

**ID Number**  
\_\_\_\_\_  
**Inspection Date:**  
\_\_\_\_\_  
**Next Inspection:**  
\_\_\_\_\_  
**Inspection by:**  
\_\_\_\_\_

RED colour

**ID Number**  
\_\_\_\_\_  
**Inspection Date:**  
\_\_\_\_\_  
**Next Inspection:**  
\_\_\_\_\_  
**Inspection by:**  
\_\_\_\_\_

Yellow colour

**ID Number**  
\_\_\_\_\_  
**Inspection Date:**  
\_\_\_\_\_  
**Next Inspection:**  
\_\_\_\_\_  
**Inspection by:**  
\_\_\_\_\_

Green colour

**ID Number**  
\_\_\_\_\_  
**Inspection Date:**  
\_\_\_\_\_  
**Next Inspection:**  
\_\_\_\_\_  
**Inspection by:**  
\_\_\_\_\_

Blue colour

**ID Number**  
\_\_\_\_\_  
**Inspection Date:**  
\_\_\_\_\_  
**Next Inspection:**  
\_\_\_\_\_  
**Inspection by:**  
\_\_\_\_\_

Black colour

**ID Number**  
\_\_\_\_\_  
**Inspection Date:**  
\_\_\_\_\_  
**Next Inspection:**  
\_\_\_\_\_  
**Inspection by:**  
\_\_\_\_\_

White colour

## Next Test

**Ref. No.**  
\_\_\_\_\_  
**Next Test Date**  
\_\_\_\_\_  
\_\_\_\_\_  
\_\_\_\_\_



TL - i2-MASH

## PAT Testing

**REF. NO.**  
\_\_\_\_\_  
**VIB. MAGNITUDE**  
\_\_\_\_\_  
**MAX. DAILY USE**  
\_\_\_\_\_  
**NOISE LEVEL**  
\_\_\_\_\_  
**TEST DATE**  
\_\_\_\_\_  
\_\_\_\_\_



TL - i3-MASH

## Harness Inspection

**Ref. No.**  
\_\_\_\_\_  
**S.W.L.**  
\_\_\_\_\_  
**Next Insp. Date Due**  
\_\_\_\_\_  
\_\_\_\_\_



TL - i4-MASH

## Vibration Control

**PASSED FOR ELECTRICAL SAFETY**  
**BY**  
\_\_\_\_\_  
**DATE**  
\_\_\_\_\_  
**NEXT DUE REF.**  
\_\_\_\_\_  
\_\_\_\_\_



TL - i5-MASH

Inserts Size : 50 x 35 mm

## UNITAG TAG & HOLDER

- ☛ The Unitag holder is an extremely robust permanent locking holder and insert system to help ensure security in terms of attachment. Once the two parts of the holder are locked together, it can only be removed with the use of wire cutters or pliers. Designed to operate with the Unitag insert systems and other control procedures employed on site.
- ☛ Material : Tag Holder made of super grade ABS plastic and inserts made of 0.5mm special grade PVC sheet.
- ☛ The Unitag holder is Fitted with 200, 275mm PVC stroop and 300mm stainless steel stroops (as per customer requirement).
- ☛ Optional standard / customised inserts are available in a variety of colours.
- ☛ 3 Types Unitag kit available :-

### TL - UTH - S KIT

Unitag Tag Holder - Small kit includes, 20 holders, 20 stroops (PVC 200mm stroop), 20 tags and 1 pen.

### TL - UTH - M KIT

Unitag Tag Holder - Medium kit includes, 20 holders, 20 stroops (PVC 275mm stroop), 20 tags and 1 pen.

### TL - UTH - B KIT

Unitag Tag Holder - Big kit includes, 20 holders, 20 stroops (300mm Stainless Steel stroop), 20 tags and 1 pen.



**TL - 200 PVC-S UTH**

Taj Loto - 200mm PVC Stroop for Unitag Tag Holder



**TL - 275 PVC-S UTH**

Taj Loto - 275mm PVC Stroop for Unitag Tag Holder



**TL - 300 SSS UTH**

Taj Loto - 300mm Stainless Steel Stroop for Unitag Tag Holder



**TL - UTH - 300 SSS**  
Taj Loto - Unitag Tag Holder with 300mm Stainless Steel Stroop



**TL - UTH**  
Taj Loto - Unitag Tag Holder

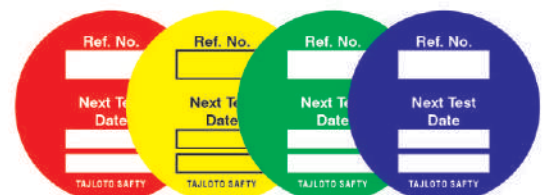

**TL - T - UTH**  
Taj Loto - Tag for Unitag Tag Holder  
Tag Size : 42mm Dia  
(Note : Design on self adhesive die cut vinyl)

## CABLE MANAGER



- ⚠ Avoid tripping accidents by smaller cables by using the cable management product. The Cable Manager unique reverse hook arrangement allows cables to be quickly and easily loaded and locked into a row and held tight between two fixed spaces up to 4 - 5 meters apart.
- ⚠ It allows cables to be easily removed individually & facilitates use by multiple users.
- ⚠ Cable Manager can be directly mounted (vertically or horizontally) on the uneven surface, poles, walls, ceiling, scaffolds, floors, wire mesh fencing, etc with just two screws / PVC cable ties or nails.
- ⚠ **Moulded in a durable thermoplastic polymer.** Designed for harsh environments and ensure maximum safety.
- ⚠ Withhold up to five standard 110v or 240v cables ranging from 8 to 11 mm in diameter.

**TL - CM**  
Taj Loto - Cable Manager  
(Size : 8.875" x 3")



## LOCKOUT / TAGOUT SIGNS & LABELS

*Lockout Tagout Signs & Labels keep help your employees and visitors safe in your facility.*

*Identify energy control points that require lockout and send a clear warning that will help keep workers aware of any potential hazards near equipment, machinery and electricity.*

*Lockout signs are available in a wide range with CAUTION and WARNING formats, sign sizes and styles also differ from each other.*

*Customized signs are made as per the requirement of machines / plant areas.*

DOMESTIC | [tajlotoindia@gmail.com](mailto:tajlotoindia@gmail.com)  
EXPORT | [tajlotoexport@gmail.com](mailto:tajlotoexport@gmail.com)



[tajlotosafety@gmail.com](mailto:tajlotosafety@gmail.com)  
[www.tajlotosafety.in](http://www.tajlotosafety.in)

## LOCKOUT / TAGOUT SIGNS

- ☛ Identify energy control points that require lockout and send a clear warning that will help keep workers aware of any potential hazards near equipment, machinery and electricity.
- ☛ Lockout Signs are available in self-stick / aluminium / sun board / base formats.
- ☛ Customized signs in different languages, formats, sizes, captions, message, etc. can be made and supplied as per the requirements of LOTO policy and procedures of individual companies.
- ☛ Lockout Signs are **available** in different **sizes** - 8" x 10" inch / 6" x 7.5" inch / 3" x 3.75" inches.
- ☛ Kindly confirm the size of the sign before ordering.



TL - SIGN-1



TL - SIGN-2



TL - SIGN-3



TL - SIGN-4



TL - SIGN-5



TL - SIGN-6



TL - SIGN-7



TL - SIGN-8



TL - SIGN-9



TL - SIGN-10



TL - SIGN-11

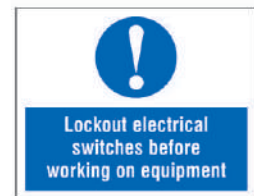

TL - SIGN-12



TL - SIGN-13

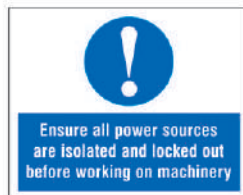

TL - SIGN-14



TL - SIGN-15

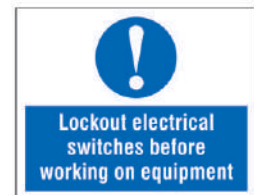

TL - SIGN-16



TL - SIGN-17

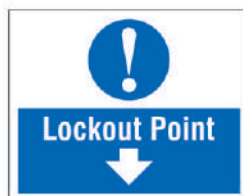

TL - SIGN-18



TL - SIGN-19



TL - SIGN-20

## LOCKOUT / TAGOUT SIGNS

- Lockout Signs are available in different sizes - 8" x 10" inch / 6" x 7.5" inch / 3" x 3.75" inches.
- Kindly confirm the size of the sign before ordering.



TL - SIGN-21



TL - SIGN-22



TL - SIGN-23



TL - SIGN-24



TL - SIGN-25



TL - SIGN-26



TL - SIGN-27



TL - SIGN-28



TL - SIGN-29



TL - SIGN-30



TL - SIGN-31



TL - SIGN-32

## LOCKOUT / TAGOUT MAGNETIC SIGNS

- Magnetic signs are ideal for quick and easy attachment next to lockout points giving a clear message.
- Customization accepted in different languages, formats, sizes, captions, message, etc.



TL - MAG-S 1



TL - MAG-S 2



TL - MAG-S 3



TL - MAG-S 4

Taj Loto - Magnetic Sign - Size: 4" x 8" inch



All the signs shown in this catalogue can be made as magnetic sign on request.



## LOCKOUT / TAGOUT LARGE SIGNS

Large Lockout Signs are available in self-stick / Aluminium base / Sun board base and on ACP sheet. **Size - 18" X 24"** inch.



TL - LAS-1



TL - LAS-2



TL - LAS-3



TL - LAS-4



TL - LAS-5

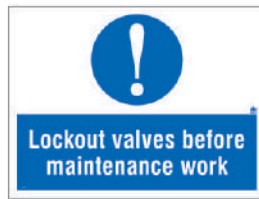

TL - LAS-6

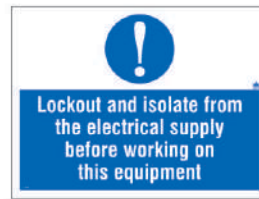

TL - LAS-7



TL - LAS-8

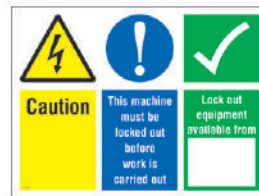

TL - LAS-9



TL - LAS-10

## LOCKOUT / TAGOUT HANGING SIGNS

These hanging lockout signs are used during maintenance /servicing and testing. Hanging Signs are available in / Aluminium base / Sun board base /ACP sheet / PVC sheet.

Signs are available in different sizes- 8" x 6" / 6" x 9" / 18" x 24" inches.



Size : 8" x 6"



TL - HAS-1



TL - HAS-2



TL - HAS-3



TL - HAS-4



TL - HAS-5



in different languages, formats, sizes, captions, message, etc.

Taj Loto - Hanging Sign (Size : 6" x 9")



TL - HAS-6



TL - HAS-7



TL - HAS-8

Taj Loto - Hanging Sign (Size : 18" x 24")

# LOCKOUT TAGOUT SIGNS & LABELS



**TAJLOTO SAFETY PVT. LTD.**  
LOCKOUT TAGOUT MANUFACTURER

## SAFETY LOCKOUT POINT MARKING

- They are normally stuck on the electrical panels / machines / pipe lines, etc. to highlight the location of the switches / valves / sockets, etc. where the lockout devices are to be installed.
- To apply, just peel of the label from the liner and apply to any clean surface.



**TL - SLPM - 1**  
Taj Loto - Safety Lockout Point Marking  
(Size : 1.5" x 3" inch)  
1 Set of 20 pcs. (10+10)



**TL - SLPM - 2**  
Taj Loto - Safety Lockout Point Marking  
(Size : 2" x 4" inch)  
1 Set of 10 pcs. (5+5)



**TL - SLPM - 3**  
Taj Loto - Safety Lockout Point Marking  
(Size : 2" x 4" inch)  
1 Set of 10 pcs. (5+5)



**TL - SLPM - 4**  
Taj Loto - Safety Lockout Point Marking  
(Size : 2" x 2.75" inch)  
1 Set of 10 pcs. (5+5)



**TL - SLPM - 5**  
Taj Loto - Safety Lockout Point Marking  
(Size : 2" x 2.75" inch)  
1 Set of 10 pcs. (5+5)

**TL - SLPM - 6**  
Taj Loto - Safety Lockout Point Marking  
(Size : 4" x 3" inch)  
1 Set of 4



## SAFETY LOCKOUT HELMET LABELS

- Show certified Lockout Tagout trained employees with a safety helmet labels that stands out. Safety Helmet labels can help you identify trained staff in seconds.
- Material; self stick vinyl.



**TL - SLHL - 1**



**TL - SLHL - 2**



**TL - SLHL - 3**



**TL - SLHL - 4**



**TL - SLHL - 5**



**TL - SLHL - 6**

Size : 2" inch diameter

**ALL HELMET LABELS  
COME WITH SET OF 10 PIECES**



**TL - SLHL - 7**



**TL - SLHL - 8**



**TL - SLHL - 9**



**TL - SLHL - 10**



**TL - SLHL - 11**

Size :  
2.5" x 2.5" inch



# LOCKOUT POSTERS

These informative Lockout Posters are a valuable asset to every company, especially when used in conjunction with training and lockout policies. The information will help employees understand lockout, help prevent injuries and save lives by communicating safe lockout / tagout procedure & instructions.

Posters can be made and supplied in all the Indian & International languages.



DOMESTIC | [tajlotoindia@gmail.com](mailto:tajlotoindia@gmail.com)  
 EXPORT | [tajlotoexport@gmail.com](mailto:tajlotoexport@gmail.com)

[tajlotosafety@gmail.com](mailto:tajlotosafety@gmail.com)  
[www.tajlotosafety.in](http://www.tajlotosafety.in)

# LOCKOUT TAGOUT POSTER



**TAJLOTO SAFETY PVT. LTD.**  
LOCKOUT TAGOUT MANUFACTURER

## LOCKOUT POSTERS

All the Lockout Posters shown in these pages can be made and supplied with your company logo / address / dept. name / phone number / e-mail id / website or any other required information can be incorporated at an additional nominal cost.

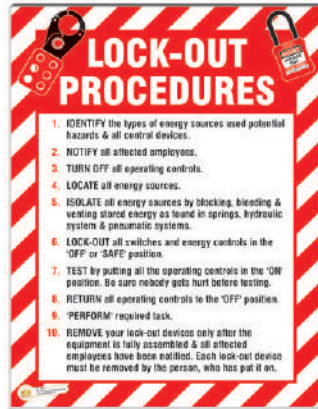

TL - LP 01 Tajloto - Lockout Poster



TL - LP 02 Tajloto - Lockout Poster



TL - LP 03 Tajloto - Lockout Poster

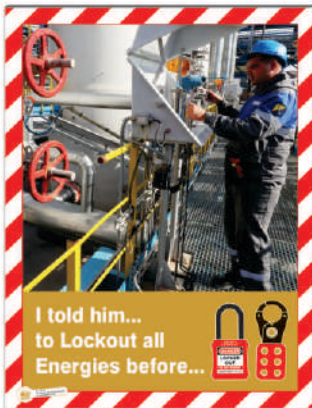

TL - LP 04 Tajloto - Lockout Poster

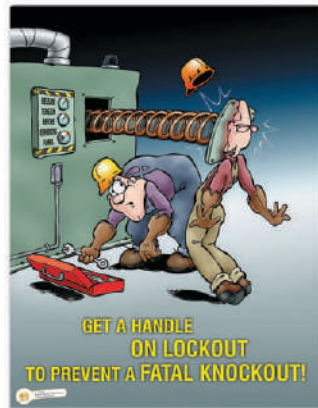

TL - LP 05 Tajloto - Lockout Poster

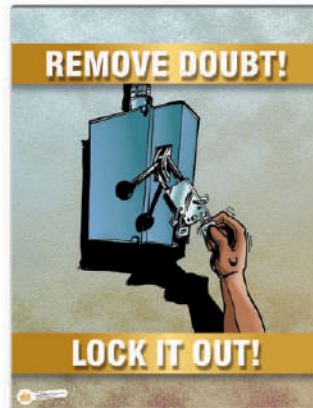

TL - LP 06 Tajloto - Lockout Poster



TL - LP 07 Tajloto - Lockout Poster

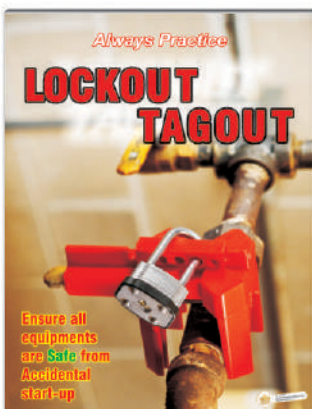

TL - LP 08 Tajloto - Lockout Poster

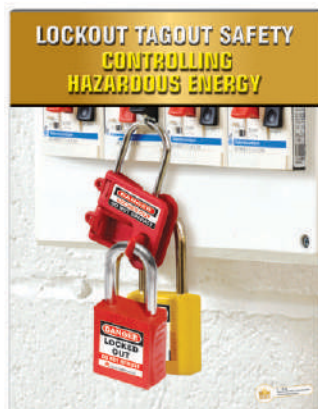

TL - LP 09 Tajloto - Lockout Poster



TL - LP 10 Tajloto - Lockout Poster



TL - LP 11 Tajloto - Lockout Poster

Available Sizes :- 45 x 60cm, 90 x 120cm, 60 x 90cm

# LOCKOUT TAGOUT POSTER



**TAJLOTO SAFETY PVT. LTD.**  
LOCKOUT TAGOUT MANUFACTURER



TL - LP 12 Tajloto - Lockout Poster

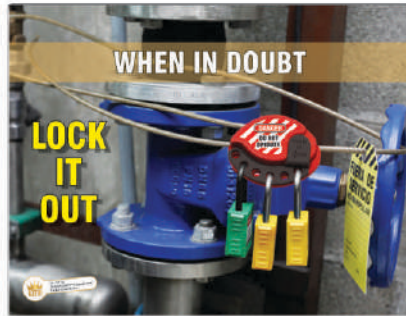

TL - LP 13 Tajloto - Lockout Poster



TL - LP 14 Tajloto - Lockout Poster



TL - LP 15 Tajloto - Lockout Poster



TL - LP 16 Tajloto - Lockout Poster



TL - LP 17 Tajloto - Lockout Poster



TL - LP 18 Tajloto - Lockout Poster



TL - LP 19 Tajloto - Lockout Poster

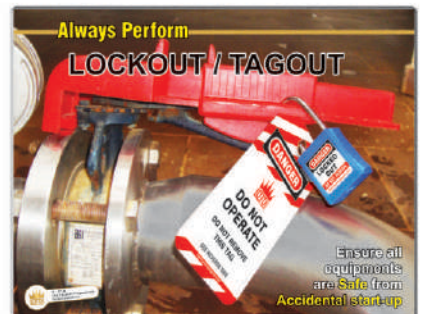

TL - LP 20 Tajloto - Lockout Poster



TL - LP 21 Tajloto - Lockout Poster



TL - LP 22 Tajloto - Lockout Poster



TL - LP 23 Tajloto - Lockout Poster

Available Sizes :- 45 x 60cm, 90 x 120cm, 60 x 90cm

# LOCKOUT TAGOUT POSTER



**TAJLOTO SAFETY PVT. LTD.**  
LOCKOUT TAGOUT MANUFACTURER

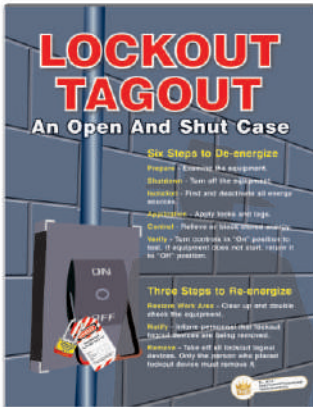

TL - LP 24 Tajloto - Lockout Poster



TL - LP 25 Tajloto - Lockout Poster



TL - LP 26 Tajloto - Lockout Poster



TL - LP 27 Tajloto - Lockout Poster



TL - LP 28 Tajloto - Lockout Poster



TL - LP 29 Tajloto - Lockout Poster



TL - LP 30 Tajloto - Lockout Poster



**TAMIL**



**HINDI**



**GUJARATI**

Available in all languages.

Tajloto - POSTERS are made on

- Self Stick Vinyl
- 3mm PVC Foam Board
- 3mm ACP (Aluminium composite)
- 1mm Aluminium Sheet

Available Sizes :- 45 x 60cm, 90 x 120cm, 60 x 90cm

All the posters shown in this catalogue can be made as poster on request.





## STEERING WHEEL LOCKOUT COVER

*Steering Wheel Covers provide a visual deterrent for vehicle maintenance, with warning message to employees not to start or move vehicles. Our **Steering Wheel Covers** come in a variety of diameters and lock in place by utilizing a hasp and safety padlock.*

## CONFINED SPACE COVER LOCKOUT

***Confined space covers** are also considered as signage and barrier protection combined-in-one.*

*They are being made and supplied in accordance to OSHA requirements with the specified OSHA / local laws, warnings to restrict the unauthorized entry in to these areas. Easy to install and lockable with the help of padlocks. These covers also prevent the local workers to throw garbage in these confined spaces.*

DOMESTIC | [tajlotoindia@gmail.com](mailto:tajlotoindia@gmail.com)  
EXPORT | [tajlotoexport@gmail.com](mailto:tajlotoexport@gmail.com)



[tajlotosafety@gmail.com](mailto:tajlotosafety@gmail.com)  
[www.tajlotosafety.in](http://www.tajlotosafety.in)

## STEERING WHEEL COVER

- Steering Wheel Covers provide a visual deterrent for vehicle maintenance, with warning message to employees not to start or move vehicles.
- Steering Wheel Cover lockout is available in 3 sizes, 40 cm, 50 cm & 60 centimetre diameter to fit a wide range of vehicles.
- Brass reinforced padlock hole can be locked with a padlock or lockout hasp.



**TL - SWC 60**  
Taj Loto - Steering Wheel Cover (60 cm dia)



**TL - SWC 50**  
Taj Loto - Steering Wheel Cover (50 cm dia)



**TL - SWC 40**  
Taj Loto - Steering Wheel Cover (40 cm dia)

*Customization Accepted*



**TL - SWC-Y 60**  
Taj Loto - Steering Wheel Cover - Yellow (60 cm dia)



**TL - SWC-Y 50**  
Taj Loto - Steering Wheel Cover - Yellow (50 cm dia)



**TL - SWC-Y 40**  
Taj Loto - Steering Wheel Cover - Yellow (40 cm dia)

## CONFINED SPACE LOCKOUT COVER

These covers are also considered as signage and barrier protection combined-in-one.

We are supply the confined space lockout cover in 3 types of material.

- TL-CSLC- 1 to 4** : - is solid thick waterproof rubberized / thick PVC coated printed, stitched fabric - lockable with padlock and **TL-SCL-DE-Y**.
- TL-CSLC- 5 to 8** : - is lockable polyester net construction for ventilated areas with solid side coverings on flanges - lockable with padlock and **TL-SCL-DE-Y**.
- TL-CSLC- 9 to 12** : - is simple & economical, non lockable polyester confined space covers supplied with 1 inch velcro or elastic as per requirement.

The covers are available in 4 sizes : Small ( 20 - 23"), Medium ( 23 - 28"), Large ( 28 - 36") and Extra Large ( 32 - 39").

*Customization Accepted*

They can be supplied with different captions to suit the requirement of our customers in their languages and the governing laws of their country. Matter related to the Danger of the confined spaces is also mentioned on these covers, sometimes.



# CONFINED SPACE LOCKOUT COVER



**TAJLOTO SAFETY PVT. LTD.**  
LOCKOUT TAGOUT MANUFACTURER

## CONFINED SPACE LOCKOUT COVER



**TL - CSLC - 1**  
Size : 32 - 39 inch dia



**TL - CSLC - 2**  
Size : 28 - 36 inch dia



**TL - CSLC - 3**  
Size : 23 - 28 inch dia



**TL - CSLC - 4**  
Size : 20 - 23 inch dia



**TL - CSLC - 5**  
Size : 32 - 39 inch dia



**TL - CSLC - 6**  
Size : 28 - 36 inch dia



**TL - CSLC - 7**  
Size : 23 - 28 inch dia



**TL - CSLC - 8**  
Size : 20 - 23 inch dia



**TL - CSLC - 9**  
Size : 32 - 39 inch dia



**TL - CSLC - 10**  
Size : 28 - 36 inch dia



**TL - CSLC - 11**  
Size : 23 - 28 inch dia



**TL - CSLC - 12**  
Size : 20 - 23 inch dia



*Customization  
Accepted*

Sign for confined space lockout cover



**TL - S CSLC - A**



**TL - S CSLC - B**



**TL - S CSLC - C**



**TL - S CSLC - D**



**TL - S CSLC - E**



## SAFETY DATA SHEETS

### TAJLOTO SAFETY

**Information** to do with the properties of hazardous chemicals is provided in Material Safety Data Sheets (MSDSs), also known as Safety Data Sheets (SDSs) or Product Safety Data Sheets. Each SDS should provide comprehensive information about the chemical that allows employers and workers to obtain relevant, and accurate information that can be put in perspective with regard to the hazards, uses, and risk management of the chemical product in the workplace. It contains information about chemical properties, health and physical hazards, first aid and medical treatment, emergency response, and the handling and disposal of chemicals. The SDS should be concise and immediately accessible and usable.

DOMESTIC | [tajlotoindia@gmail.com](mailto:tajlotoindia@gmail.com)  
EXPORT | [tajlotoexport@gmail.com](mailto:tajlotoexport@gmail.com)



[tajlotosafety@gmail.com](mailto:tajlotosafety@gmail.com)  
[www.tajlotosafety.in](http://www.tajlotosafety.in)

## Safety Data Sheets Box



### TL - SDS-BS R

TAJ LOTO

Safety Data Sheets Box Small

Size -: 175 x 250mm (Red)

### TL - SDS-BM R

TAJ LOTO

Safety Data Sheets Box Medium

Size -: 240 x 350mm (Red)

### TL - SDS-BL R

TAJ LOTO

Safety Data Sheets Box Large

Size -: 240 x 380mm (Red)

TajLoto SDS made of special grade metallic sheet. Duly powder coated and supplied with multiple slots in the box body and its flap for holding lockout Used for Safety Data Sheets Box lockouts.

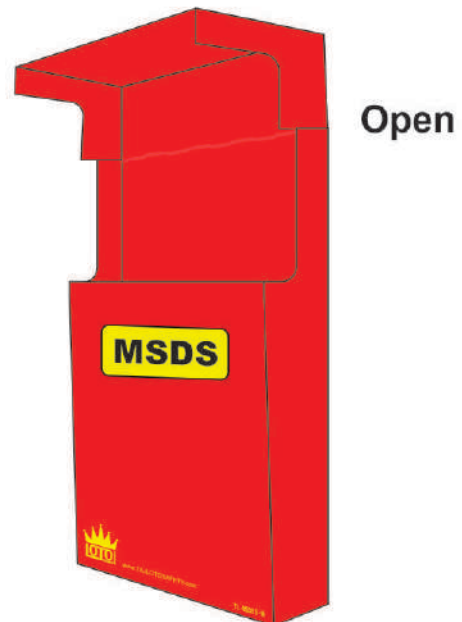

All Safety Data Sheets available in red colour if you want other colours like yellow, blue, green etc. / your company logo your department name /



Minimum Quantity Applicable

## Safety Data Sheets File



TL - SDS-F 01  
TAJ LOTO  
Safety Data Sheets File

TajLoto SDS made of special grade Hard board & PVC Duty laminated coated and supplied with multiple slots in the file body and its paper clip for holding lockout Used for Safety Data Sheets file lockouts.



TL - SDS-F 02  
TAJ LOTO  
Safety Data Sheets File



TL - SDS-F 03  
TAJ LOTO  
Safety Data Sheets File



TL - SDS-F 04  
TAJ LOTO  
Safety Data Sheets File



TL - SDS-F 05  
TAJ LOTO  
Safety Data Sheets File



Minimum Quantity Applicable

## Safety Data Sheets Station



**TL - SDS-S R**  
TAJ LOTO  
Safety Data Sheets Station  
Size -: 13" x 19" (Red)



**TL - SDS-S R&W**  
TAJ LOTO  
Safety Data Sheets Station  
Size -: 13" x 22" (Red&White)

TajLoto SDS made of special grade Hard board & ACP (Aluminium Composite Panel) Duly laminated coated and supplied with multiple slots in the Station and its steel frame for file holding lockout Used for Safety Data Sheets Station lockouts.



**TL - SDS-S R**  
TAJ LOTO  
Safety Data Sheets Station  
Size -: 26" x 19" (Red)

ACP (Aluminium Composite Panel)

PVC Hard board



Minimum Quantity Applicable

## Safety Data Sheets Station



**TL - SDS-S Y**  
TAJ LOTO  
Safety Data Sheets Station  
Size -: 13" x 19" (Yellow)



**TL - SDS-S R&W**  
TAJ LOTO  
Safety Data Sheets Station  
Size -: 26" x 22" (Red&White)



**TL - SDS-S Y**  
TAJ LOTO  
Safety Data Sheets Station  
Size -: 26" x 19" (Yellow)

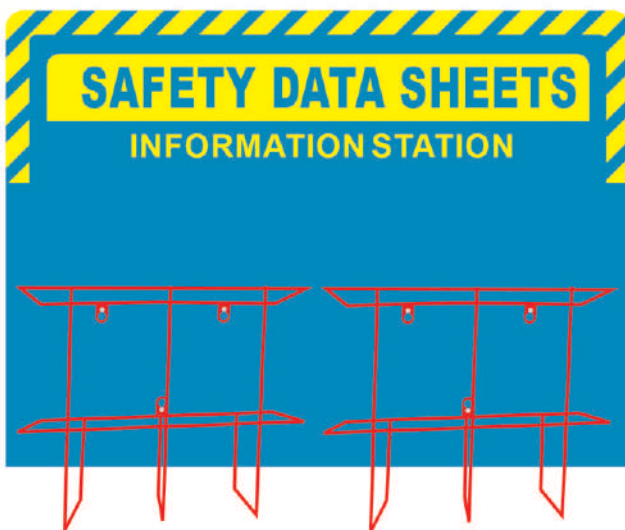

**TL - SDS-S B**  
TAJ LOTO  
Safety Data Sheets Station  
Size -: 26" x 19" (BLUE)



## Safety Data Sheets INFORMATION Sign

TajLoto SDS made of special grade Hard board & ACP Duly laminated coated and supplied with multiple slots in the Sign and its Self stick Vinyl lockout Used for Safety Data Sheets INFORMATION Sign lockouts.



**TL - SDSIS 01**  
TAJ LOTO  
Safety Data Sheets  
INFORMATION Sign  
Size -: 8" x 8"



**TL - SDSIS 02**  
TAJ LOTO  
Safety Data Sheets  
INFORMATION Sign  
Size -: 8" x 8"



**TL - SDSIS 03**  
TAJ LOTO  
Safety Data Sheets  
INFORMATION Sign  
Size -: 6" x 8"



**TL - SDSIS 04**  
TAJ LOTO  
Safety Data Sheets  
INFORMATION Sign  
Size -: 6" x 8"



**TL - SDSIS 05**  
TAJ LOTO  
Safety Data Sheets  
INFORMATION Sign  
Size -: 18" x 8"



**TL - SDSIS 06**  
TAJ LOTO  
Safety Data Sheets  
INFORMATION Sign  
Size -: 18" x 8"

ACP (Aluminium Composite Panel)

Self stick Vinyl

PVC Hard board

1mm Aluminium Sheet



Minimum Quantity Applicable

## Safety Data Sheets INFORMATION Sign



**TL - SDSIS 07**  
TAJ LOTO  
Safety Data Sheets  
INFORMATION Sign  
Size -: 6" x 6"

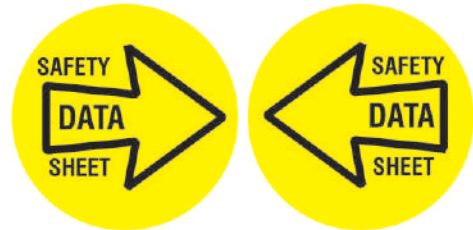
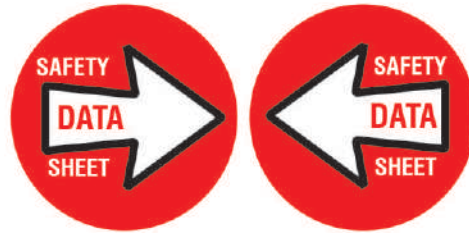

**TL - SDSIS 08**  
TAJ LOTO  
Safety Data Sheets  
INFORMATION Sign  
Size -: 6" x 6"

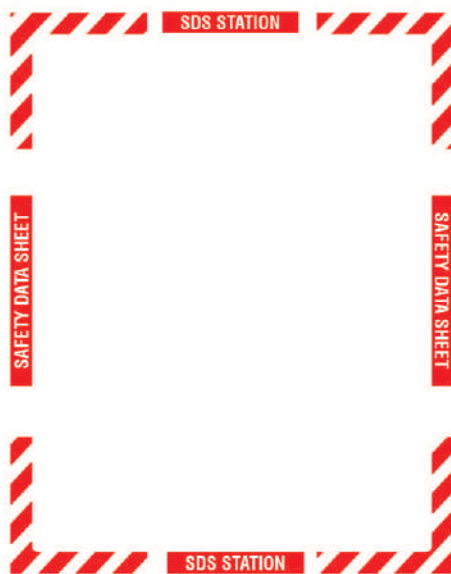

**TL - SDSIS 09**  
TAJ LOTO  
Safety Data Sheets  
INFORMATION Sign  
Size -: 6" x 6"



Minimum Quantity Applicable



# LOCKOUT / TAGOUT OTHER PRODUCTS

*There is mixed category of Lockout Tagout Products; which help in successfully performing the lockout / tagout procedures and policies.*



DOMESTIC | [tajlotoindia@gmail.com](mailto:tajlotoindia@gmail.com)  
EXPORT | [tajlotoexport@gmail.com](mailto:tajlotoexport@gmail.com)

[tajlotosafety@gmail.com](mailto:tajlotosafety@gmail.com)  
[www.tajlotosafety.in](http://www.tajlotosafety.in)

## LOCKOUT BARRIER TAPE

Lockout barrier tape is very helpful for temporary barrier and ideal for prohibiting access to unauthorized areas during lockout procedures.

Material : Tape made from non-adhesive polyethylene. Supplied in roll form in 3" inch x 310 mtrs.

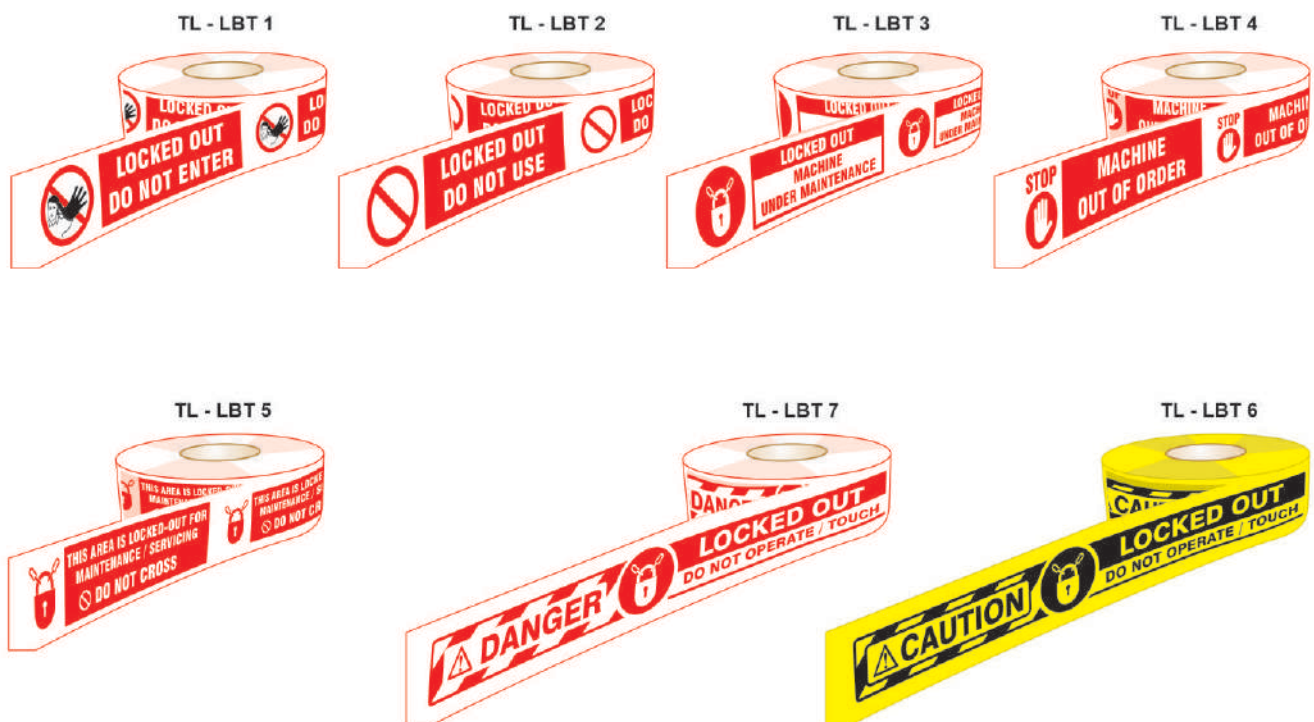
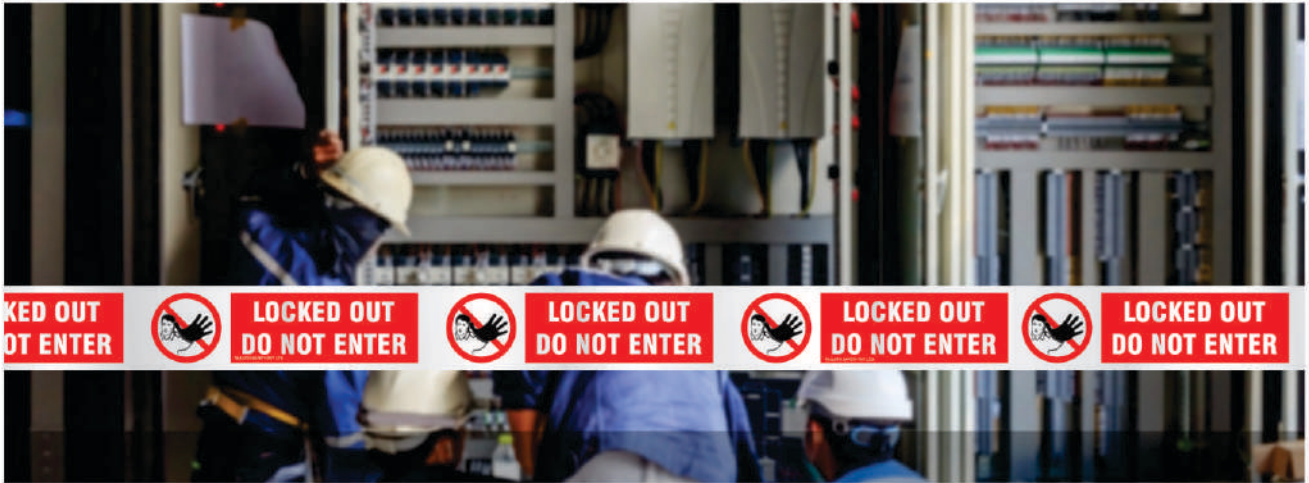

Minimum quantity 25 Rolls.

## LOCKOUT INFORMATION FLOOR STAND

Our Lockout Information stand helps to display a clear message right where it is needed. Message is printed on both sides of stand for better visibility. Lockout information floor stand is lightweight and durable. Polypropylene stand resists most chemicals. **Size : 24" x 12" inch**



TL - LIFS - A



TL - LIFS - B



TL - LIFS - C



*Minimum quantity applicable.*

## LOCKOUT / TAGOUT PERMIT HOLDER

Permit / document holder made in clear flexible sheeting to safe guard the permits issued for Lockout / Tagout and other purposes to always make them available to the person concerned. This zipper pouch is convenient to use and easy to hang on the walls near the machines.

TL - PERMIT HOLDER



## LOCKOUT / TAGOUT PERMIT SAFE HOLDER

Single hinged permit safe holder allow a single sided document to be shown.

**Can lock the permit safe holder by using padlock.** Because of which no one can tamper with the document.

This Permit safe holder is wall mounted / clear PVC front / easy to use and you can hold permit to work and documentation (A4 size) as part of a lockout system.

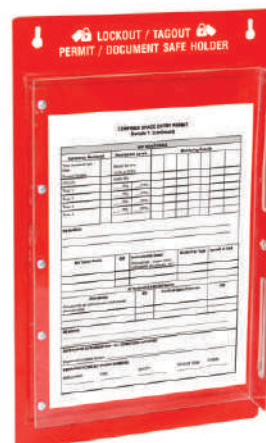

TL - LTPSH  
Taj Loto - Lockout tagout  
permit safe holder



# LOCKOUT BARRICADING SYSTEM

*The lockout barricading system is very helpful when we doing maintaining or servicing on machine.*

*Quick and effective way of creating a temporary barrier and ideal for prohibition access to unauthorized areas during lockout procedures.*



DOMESTIC | [tajlotoindia@gmail.com](mailto:tajlotoindia@gmail.com)  
EXPORT | [tajlotoexport@gmail.com](mailto:tajlotoexport@gmail.com)

[tajlotosafety@gmail.com](mailto:tajlotosafety@gmail.com)  
[www.tajlotosafety.com](http://www.tajlotosafety.com)

## LOCKOUT BARRICADING SYSTEM

Steel Based with heavy rubber post with wide 14" dia . PVC Chain post for cordoning off lockout areas. They can be quickly & easily deployed. Highly visible, post are available in **Red / White** or **Black / Yellow** combinations.

Overall Height : 43" Post height with the top cap & 49" with the display sign. Black Base is of 14" diameter.



**TL - BSL - 1P 1S R/W**  
TAJLOTO- Barricading System  
Lockout With 1 Pole 1 Sign  
Red/White



**TL - BSL - 1P Y/B**  
TAJLOTO- Barricading System  
Lockout With 1 Pole  
Yellow/Black



**TL - BSL - 2P 1S R/W**  
TAJLOTO- Barricading System  
Lockout With 2 Poles 1 Sign  
Red/White



**TL - BSL - 4P 1S R/W**  
TAJLOTO- Barricading System  
Lockout With 4 Poles 1 Sign  
Red/White



**TL - BSL - 3P 1S R/W**  
TAJLOTO- Barricading System  
Lockout With 3 Poles 1 Sign  
Red/White



**TL - BSL - 4P 1S Y/B**  
TAJLOTO- Barricading System  
Lockout With 4 Poles 1 Sign  
Yellow/Black

*Customization Accepted*

We can make according to your requirements

*\*Minimum quantity Applicable*

## LOCKOUT / TAGOUT SUGGESTION BOX

This suggestion box, is perfect for collecting comments or suggestions from your employees, customers, or visitors.

It is made up of solid steel sheets and powder coated / **printed as per the requirement of the customers.**

The lock & key feature allows its contents to be securely contained.

Standard colour is yellow and size - 12" x 9" x 3" inches.



TL - SG BOX  
Taj Loto -  
Suggestion Box

## LOCKOUT / TAGOUT RECORD REGISTER

RECORD REGISTER (A4 size) are used by each and every department separately for keeping a full record of the LOCKOUT / TAGOUT procedures followed in the department and also used for keeping the record of what all products are used by whom, how much period, for which purpose and which specific machine / location etc.

These registers ensure that the whole Lockout / Tagout process is followed and implemented in a perfect way and the same has been understood and recorded as per the company Lockout Policy.



## LOCKOUT / TAGOUT POUCH & BAG

These pouches & bags are specially made from waterproof heavy duty rubberised Nylon cloth in various colors to suit the requirements of our customers and are supplied with their own logo / text and graphics in their own language. Depending on the usage, the hanging / belting / velcro, zipper arrangements are given. All possible customization are accepted depending on the minimum order quantities.



## LOCKOUT TAGOUT BAGS POUCHS

*Lockout Tagout kits allow Bag to combine and organise regularly used equipment, fabric and leather in pvc lockout bag and box. Lockout Kits bag have been specifically designed for use within various different industries and applications to ensure that workers get the necessary tools to implement and carry out lockout procedures All the bag can be customized as per your individual requirements and if ordered in volumes\* - Name of the Company / Logo / Department Name etc. can also be printed on these bags.*



DOMESTIC | [tajlotoindia@gmail.com](mailto:tajlotoindia@gmail.com)  
EXPORT | [tajlotoexport@gmail.com](mailto:tajlotoexport@gmail.com)

[tajlotosafety@gmail.com](mailto:tajlotosafety@gmail.com)  
[www.tajlotosafety.com](http://www.tajlotosafety.com)

## Safety LOCKOUT BAG

TajLoto kit bag made of special grade fabric & steel clasp and with black strip and heavy duty zipper for holding strip lockout Used in lockout bag



**TL - LB R/Y - S**  
TAJ LOTO  
Lockout Bag Red / Yellow Small



**TL - LB R/Y - M**  
TAJ LOTO  
Lockout Bag Red / Yellow Medium



**TL - LB R/Y - L**  
TAJ LOTO  
Lockout Bag Red / Yellow Large



**TL - LB B - S**  
TAJ LOTO  
Lockout Bag Blue Small

**TL - LB B - M**  
TAJ LOTO  
Lockout Bag Blue Medium

**TL - LB B - L**  
TAJ LOTO  
Lockout Bag Blue Large



Minimum Quantity Applicable

## Safety LOCKOUT POUCH

TajLoto kit pouch made of special grade fabric and black strip and heavy duty zipper for holding strip lockout Used in lockout pouch.



**TL - LP - 04 R**  
TAJ LOTO  
Lockout Pouch -01 Red



**TL - LP - 05 B**  
TAJ LOTO  
Lockout Pouch -05 Black



**TL - LP - 01 R**  
TAJ LOTO  
Lockout Pouch -01 Red



**TL - LP - 02 R**  
TAJ LOTO  
Lockout Pouch -01 Red



**TL - LP - 03 R**  
TAJ LOTO  
Lockout Pouch -01 Red

TajLoto Model	Size :- H-W-D
TL - LP - 01 R	8" x 10" x 4"
TL - LP - 02 R	8" x 7" x 3"
TL - LP - 03 R	9" x 5" x 3"
TL - LP - 04 R	8" x 6" x 4"
TL - LP - 05 B	7" x 6" x 4"

## Safety LOCKOUT POUCH

TajLoto kit waist pouch and box made of special grade fabric and black strip and heavy duty zipper for holding strip and pvc box lockout Used in lockout pouch and box.



**TL - L1BP - R**  
TAJ LOTO  
Lockout 1 Belt Pouch - Red



**TL - L3BP - R**  
TAJ LOTO  
Lockout 3 Belt Pouch - Red



**TL - L1BP - B**  
TAJ LOTO  
Lockout 1 Belt Pouch - Black



**TL - LB - 14**  
TAJ LOTO  
Lockout Box - 12inch



**TL - LB - 16**  
TAJ LOTO  
Lockout Box - 16inch

**TL - LB - 22**  
TAJ LOTO  
Lockout Box - 18inch



Minimum Quantity Applicable

## Safety LOCKOUT POUCH



**TL - LP - 06 Y**  
TAJ LOTO  
Lockout Pouch -06 Yellow



**TL - LP - 08 Y&R**  
TAJ LOTO  
Lockout Pouch -09 Yellow & Red  
Size :- 21" x 9"



**TL - LP - 07 B**  
TAJ LOTO  
Lockout Pouch -07 Black  
Size 6"x4"x2.5"

**TL - LP - 10 W**  
TAJ LOTO  
Lockout Pouch -10 White  
Size :- 14" x 11"



Minimum Quantity Applicable



**AUTHORIZED DISTRIBUTOR**



**SAFETYWALA**

Equipments LLP.



**📍 104 - Symmers, Near IBP Petrol Pump, Sarkhej Sanand Road, Ahmedabad, Gujarat - 382210 Sales Enquiry:- +91 99790 80559**

**e mail :- [sales@safetywala.in](mailto:sales@safetywala.in)**